



2024

NICT REPORT

New ICT technology strategy toward Society 5.0

A night sky filled with numerous white star trails streaking across a deep blue background. Below the sky, a dark silhouette of a mountain range is visible, with a prominent, conical mountain peak on the right. At the base of the mountains, a city is illuminated with bright white and yellow lights, creating a glowing horizon line.

**Imagine a world where the flow of information is no more.
What would it mean if communications just stopped?**

**Our lives, even their most everyday moments,
have taken shape through a succession of endeavors and innovations.**

**Our passion is to keep people in comfort and security
and co-create a vibrant society, one full of curiosity.
We will always pursue a freer, more expansive future.**

**We are transcending boundaries, forging connections,
and liberating people from constraints.**

**Beyond human intelligence,
co-create new standards for future society.
NICT**

Message from the President



The COVID-19 pandemic that overwhelmed the world finally subsided in 2023. However, grave regional conflicts—most notably the Russian invasion of Ukraine and the Israel-Hamas war—have caused global turmoil for which no end is in sight. Amid these tense circumstances, striking information and communications technology (ICT) developments are underway: new revolutionary AIs have been created, including generative AIs (or large language models) such as Open AI's ChatGPT and Google's Bard/Gemini. The advent of these AIs has led to discussion of ways in which humans and AIs can harmoniously coexist.

2024 will mark the fourth year of NICT's Fifth Medium-to-Long-term Plan implementation period. This plan specifies four strategic research areas: Beyond 5G (B5G) technologies, which we aim to put into practical use by 2030; AIs, expected to be the most important technology of the 21st century; Quantum ICT, which may revolutionize current ICT systems; and Cybersecurity crucial to protecting social infrastructure. Our R&D in these areas has made significant progress. We have also acted as a collaboration hub for R&D by Japanese and overseas organizations.

With respect to B5G technologies, NICT has considerable expertise in research on Terahertz technologies, space-time synchronization technologies and non-terrestrial networks. We have therefore been working on international standardization of these technologies through the ITU-R SG5 WP5D and 3GPP (Third Generation Partnership Project) frameworks. In addition, we have made the testbeds for B5G R&D available for use by external researchers and constructed a B5G electromagnetic wave anechoic chamber facility at NICT in efforts to expedite the development of B5G technologies across Japan. We have also provided funding to private companies, universities and other organizations carrying out B5G R&D by launching a Beyond 5G R&D Promotion Project and B5G/6G R&D funding programs. Through these efforts, we aim to accelerate the development of fundamental B5G technologies and their practical use in Japan and overseas.

In the area of AI we have been conducting R&D in line with the Global Communication Plan 2025. We are making steady progress in developing a multilingual simultaneous interpretation system with the aim of demonstrating it at the World Expo 2025 in Osaka. As part of our generative AI R&D, NICT has developed an original large language model designed specifically for use by Japanese speakers. In addition, we incorporated AI— including newly developed AI technologies—into a number of research projects related to space weather forecasting, network control, privacy-preserving federated learning, interdisciplinary research on information and neural networks and other subjects.

Our Quantum Security Innovation Hub is also now fully operational. We succeeded in experimentally demonstrating that quantum keys can be exchanged between the International Space Station and a ground station via optical communications. Moreover, we launched the NICT Quantum Camp program to train talented young people which we call Quantum Natives.

Finally, in Cybersecurity research, we established the Cybersecurity Nexus (CYNEX) in 2021, a system intended to coordinate cybersecurity efforts by the industrial, academic and public sectors. We then launched the CYNEX Alliance in October 2023 to intensify CYNEX activities. Through these efforts, we aim to strengthen Japan's Cybersecurity R&D by private companies, government organizations and educational institutions using CYNEX as a means of cross-sectoral collaboration.

NICT is Japan's sole national research institute specialized in ICT. In line with its missions, we prepared an NICT Brand Statement in 2023 in non-technical terms to convey our aspiration to expand the potential of ICT and publicized an ICT Report to inform the public of the latest trends in and future prospects for ICT R&D.

We invite public comments and suggestions about our activities. We will continue making efforts to advance ICT by cooperating and engaging in friendly competition with other ICT-related organizations in Japan and overseas and collaborating with the industrial, academic and public sectors. We appreciate your continued support and cooperation.

I'd like to end my New Year's greetings by offering a heartfelt prayer for peace in the regions affected by the current conflicts.

A handwritten signature in black ink, reading "Hideyuki Tokuda". The signature is fluid and cursive, with the first name "Hideyuki" written in a larger, more prominent style than the last name "Tokuda".

President of the National Institute of Information
and Communications Technology

Dr. TOKUDA Hideyuki

New ICT technology strategy toward Society 5.0

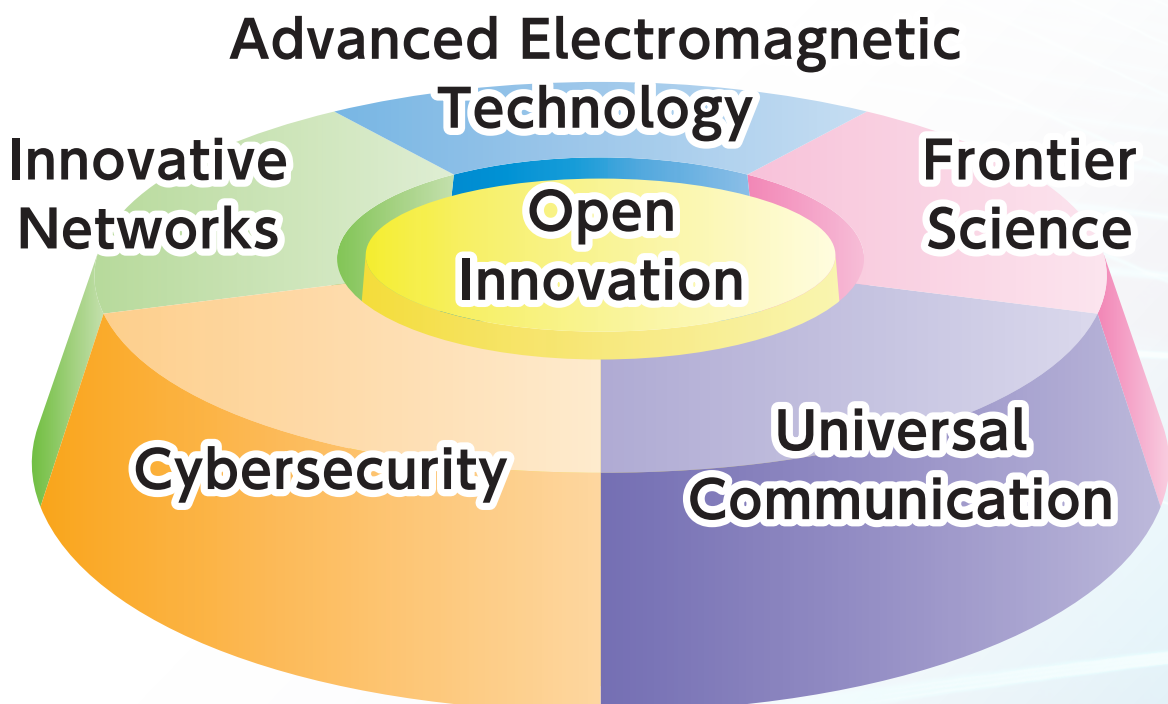
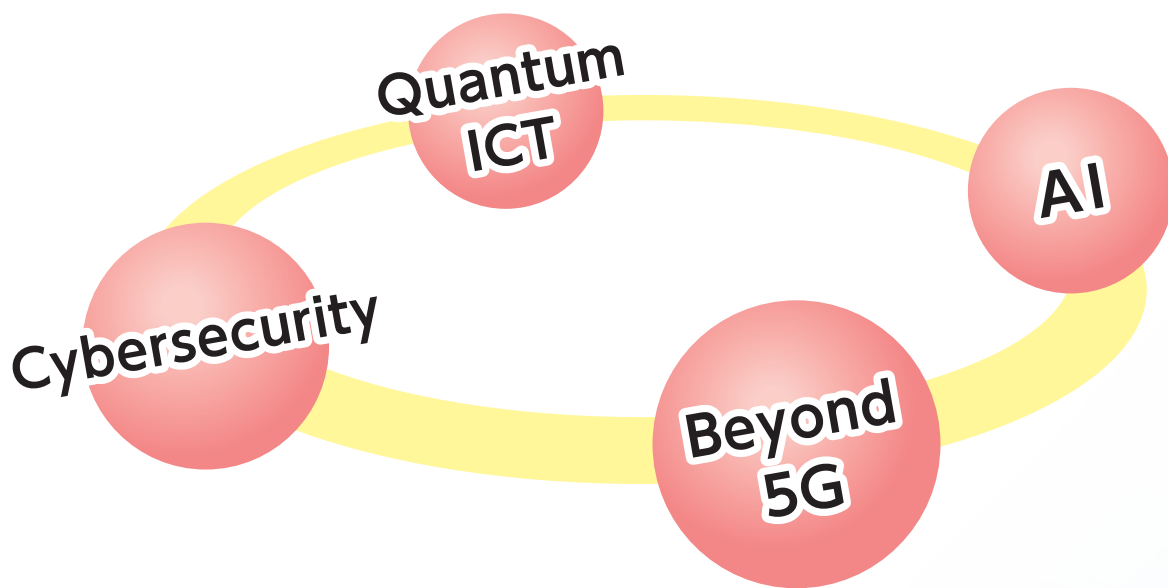

NICT's **fifth mid-to-long-term plan** (April 2021 to March 2026) inherits the "five priority R&D areas" of the fourth mid-to-long-term plan, and promotes open innovation by widely disseminating our R&D results within society.

The "five priority R&D areas" are the areas of

- **Advanced electromagnetic technology**
- **Innovative networks**
- **Cybersecurity**
- **Universal communication**
- **Frontier science**

In addition, we will promote cross-sectional and strategic R&D in four research fields that should be pursued strategically. The strategic fields are:

- **Beyond 5G**
- **AI**
- **Quantum ICT**
- **Cybersecurity**

Collaboration across fields is also important for building a total system that links elemental technologies in addition to advancing them. Through these activities, NICT is promoting **Open Innovation** in order to contribute to solving social and regional issues, digital transformation, and value creation in social systems for the new era, and achieving SDGs.

PR movie for NICT
A Future with N



<https://youtu.be/YOenAWHhRIA>

The AI robot character "N" from the year 203X explains NICT's future R&D vision in an easy-to-understand manner. We hope you enjoy it!

N
Appears in
NICT PR movie entitled
"A Future with N"

START A SCOUTER



The AI robot character "N" coming from the year 203X, developed by NICT.



Table of Contents

NICT Brand Statement

1 Message from the President

2 New ICT technology strategy toward Society 5.0

6 Research and Development

● **Advanced Electromagnetic Technology Area**

6 Radio Research Institute

● **Innovative Networks Area**

10 Network Research Institute

● **Cybersecurity Area**

14 Cybersecurity Research Institute

● **Universal Communication Area**

18 Universal Communication Research Institute

● **Frontier Science Area**

22 Advanced ICT Research Institute

● **B5G Field**

26 Beyond 5G Research and Development Promotion Unit

● **Quantum ICT Field**

28 Quantum ICT Collaboration Center

● **Open Innovation**

30 ICT Testbed Research and Development Promotion Center

32 Innovation Promotion Department

34 Global Alliance Department

36 ICT Deployment and Industry Promotion Department

38 Research Highlights

- 40 Successful Japan-Europe joint experiment on integration of satellite links in Japan-Europe long distance 5G network
- 41 International reference computational models for children released free of charge
- 42 World's first demonstration of Terahertz signal transparent relay and switching
- 44 Rocket equipped with Jupiter ICy moons Explorer (JUICE) successfully launched!
- 45 Successful development of a differential absorption Lidar that captures the flow of water vapor
- 47 The holes in the ionosphere caused by the eruption of a submarine volcano off the coast of Tonga
- 49 Successful demonstration of optical wireless communications in sunlight using Deep-Ultraviolet LED in Non-Line-Of-Sight configurations
- 51 Development of a cross-organizational analysis function of the integrated cyber attack analysis platform "NIRVANA Kai"
- 52 Building prototype Japanese language specific Large Language Models (LLM, Generative AI)
- 54 Establishment of accurate permittivity measurement technology using the Millimeter wave/ Terahertz band

56 Researchers

- 56 Person 1 Pham Tien Dat
- 57 Person 2 JIN Hidekatsu
- 58 Person 3 IWAKI Mitsuhiro

60 Overseas Centers' Activities

- 60 NICT Overseas Centers
- 61 NICT Asia Center
- 62 NICT North-America Center
- 63 NICT Europe Center

64 Organization and Fact Data

- 64 Budget and Work Force
- 65 History

66 NICT Primary Facilities

Advanced Electromagnetic Technology Area Radio Research Institute

Director General NAKAGAWA Katsuhiko

The Radio Research Institute is an organization which promotes research and development into a variety of ICT technologies, particular technologies related to electromagnetic waves, as well as activities for the application of those technologies in society. We aim to realize Society 5.0 by utilizing electromagnetic waves.

Radio Propagation Research Center

At the Radio Propagation Research Center, we promote the research and development of Earth and space environment monitoring and prediction technologies. We use electromagnetic waves to sense events in real space, reconstruct

those situations in cyberspace, use technologies such as simulations to predict the future, and feed those results back into real space, which enables risk avoidance.

Remote sensing technology

Concerning the airborne synthetic aperture radar (Pi-SAR X3), we acquired data for Mount Asama, Mount Kusatsu-Shirane,

and Mount Yake at 15 cm resolution, a first for volcanoes in peacetime.

In the development of the multi-parameter differential absorption lidar (MP-DIAL), regarding the seed laser, we succeeded in producing a low-priced practical model using a low thermal expansion material (Super Invar), and used it to conduct actual observations (Doppler measure-

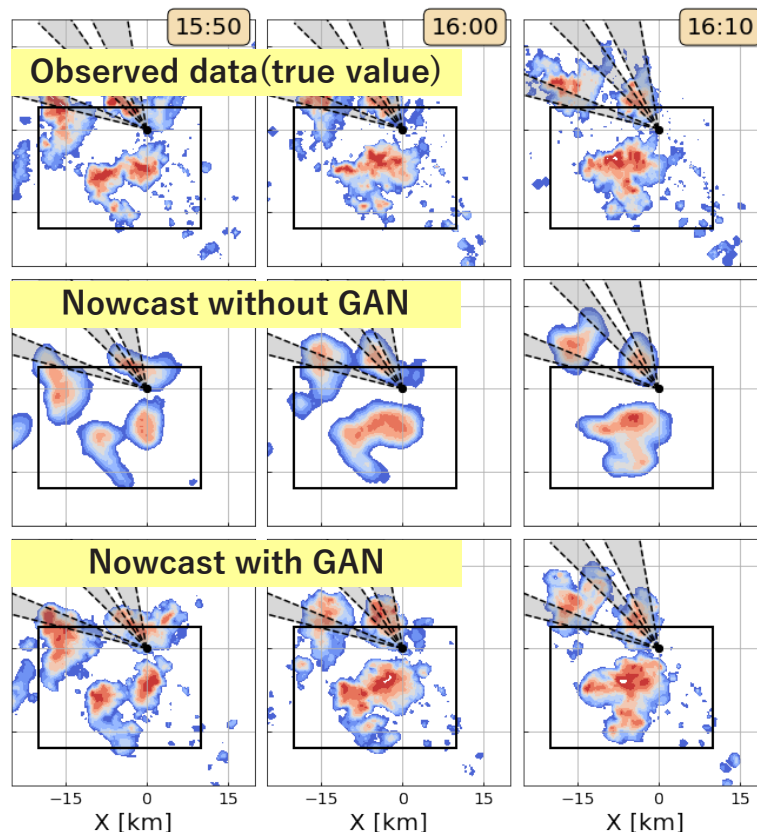

Fig.1 : Examples of prediction results of short-term precipitation Nowcast using a GAN. Top row: the actual observed data with MP-PAWR, middle row: prediction results without GAN, bottom row: prediction results with GAN

ments). In addition, we succeeded in achieving the wavelength control (± 0.2 pm) necessary to achieve the water vapor observational precision ($\pm 10\%$) stipulated by the World Meteorological Organization (WMO).

Regarding short-term prediction of rainfall utilizing MP-PAWR data and machine learning, we succeeded in using a generative adversarial network (GAN) to predict rainfall, including the fine structure, at a higher prediction accuracy than the current Nowcast, including that of the Japan Meteorological Agency (Fig. 1).

Regarding observations of the amount of water vapor using terrestrial digital broadcast waves, we worked with private-sector companies to jointly operate a cloud-based data gathering and distribution system using an observation network constructed in 15 locations in Kyushu. We also participated in the Japan Meteorological Agency's cooperative framework in the Kyushu area for elucidating the mech-

anism behind linear rainbands and promoted the utilization of the data.

Space environment technology

In order to steadily carry out the work of "monitoring, forecasting and providing warning of anomalies regarding radio wave propagation, etc." (Act on the National Institute of Information and Communications Technology ("NICT Act"), Article 14, Paragraph 1, Item 4), we implemented ionosphere observations using ionosonde 24 hours a day, 365 days a year, at our radio wave observatories in four locations in Japan and one location in Antarctica, and issued space weather forecasts.

Regarding the magnetic storm event which caused the accidental reentry of 38 Starlink satellites in February 2022, we analyzed the mechanisms of a series of space weather phenomena by using an atmosphere and ionosphere model called GAIA. GAIA reproduced the increase in neutral atmospheric mass density across a

broad region, and elucidated the cause of the satellite reentries (Fig. 2).

We implemented as planned the development of the engineering model (EM) for space environment sensors which can be installed on the successor to Himawari, and completed the basic design and manufacturing of the electronic sensors and charge sensors.

We participate in the Study Group on the Advancement of Space Weather Forecasting and the Working Group on Space Weather Alert Criteria in the Ministry of Internal Affairs and Communications, and have greatly contributed to the formulation of new forecast and alert criteria which take into consideration their social impacts, a first anywhere in the world, as well as worst-case scenarios brought about by extreme space weather phenomena, a first for Japan.

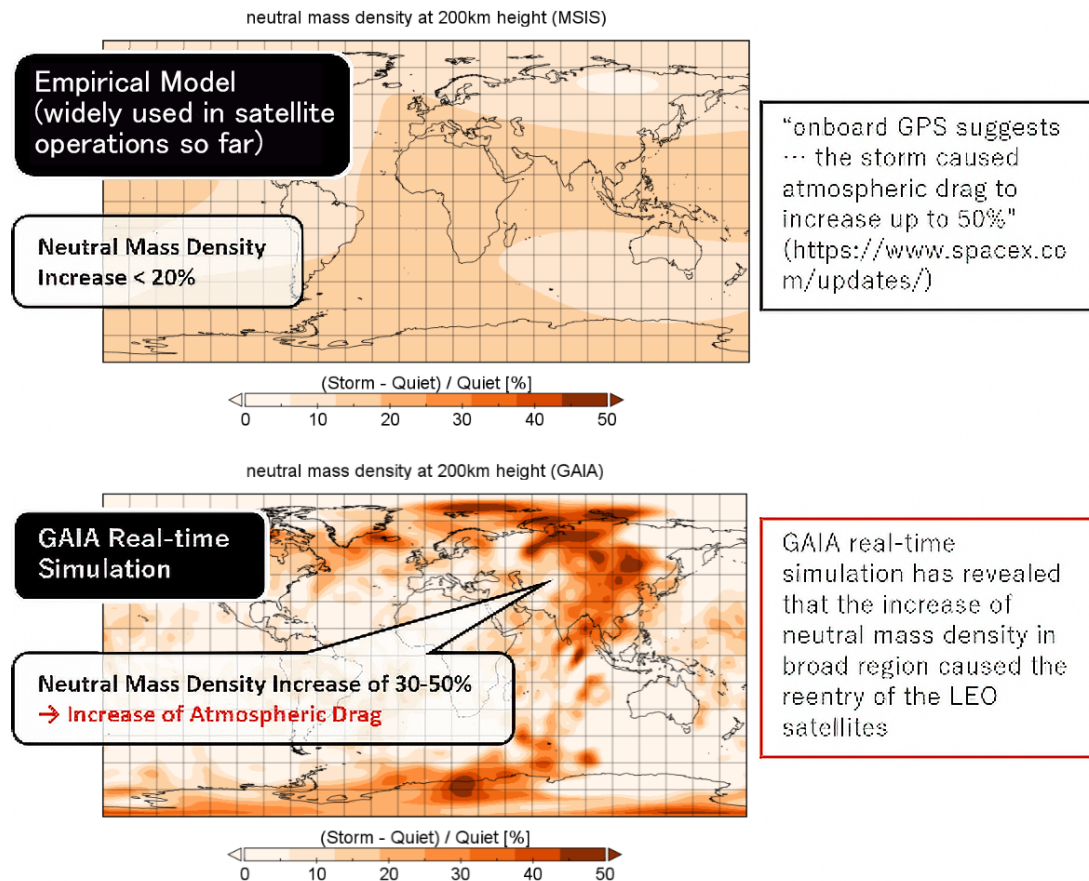

Fig.2 : The neutral atmospheric mass density at 200 km height during the magnetic storm which caused accidental reentry of 38 Starlink satellites, recreated using the GAIA atmospheric and ionospheric models

Electromagnetic Standards Research Center

Under the goal of contributing to the development of measurement standards for electromagnetic waves, which are essential for science and technology and the foundations of modern society, the Electromagnetic Standards Research Center serves two roles: one as the “standard organization that supports national and international standards” and the other as a “laboratory that conducts state-of-the-art research and development of measurement technologies.”

Electromagnetic compatibility technology

We steadily carried out the service of “testing and calibration of radio measuring equipment and frequency standard” (NICT Act, Article 14, Paragraph 1, Item 5) to contribute to the realization of fair and efficient utilization of radio waves, and to endeavor to maintain Japan’s metrology systems concerning frequency standards.

We upgraded the calibration system from 110 GHz to 330 GHz, which is necessary for research and development of B5G/6G and for which NICT offers the only calibration service in Japan (above 170 GHz, NICT is the only provider of this service anywhere in the world), and have enabled high precision and stable calibration.

In order to establish technologies for exposure assessment to radio waves of 0.3 THz for which no radio radiation protection guidelines have been formulated, we acquired the electric constant data of biological tissues up to about 0.6 THz to expand the database of electrical properties of biological tissues, and developed tissue-equivalent phantoms approximating the electrical properties of skin and corneal tissues (Fig. 3).

In order to understand the levels of radio wave exposure for children where there is great interest in safety, we carried out measurements in elementary and junior high school classrooms. The measurements revealed that children were exposed to the same levels of radio waves even using a personal computer in a classroom as in a typical residence.

Space-time standards technology

We steadily advance work on “setting frequency standard values, emitting standard radio waves, and reporting standard times” (NICT Act, Article 14, Paragraph 1, Item 3). We transmitted standard radio waves throughout 99.9% of year, and our Network Time Protocol (NTP) Service was accessed as frequently as more than ten billion times in a day.

We have changed the backup time system which will be used in the event of a disaster at the NICT Headquarters to a format for integrated use of atomic clocks at all four bases. Furthermore, we have carried out measures such as securing multi-

ple channels of communication between the Headquarters and the substations in order to strengthen the resiliency of the Japan Standard Time.

By continuously generating a time system based on a strontium optical lattice clock all through FY2022, we have reduced the changes in the time difference of Japan Standard Time with respect to coordinated universal time (UTC) to less than one-half compared to previously, and realized the regular implementation of an optical lattice clock to the standard time for the first time in the world (Fig. 4).

In addition, by utilizing the optical difference frequency generation of two acety-

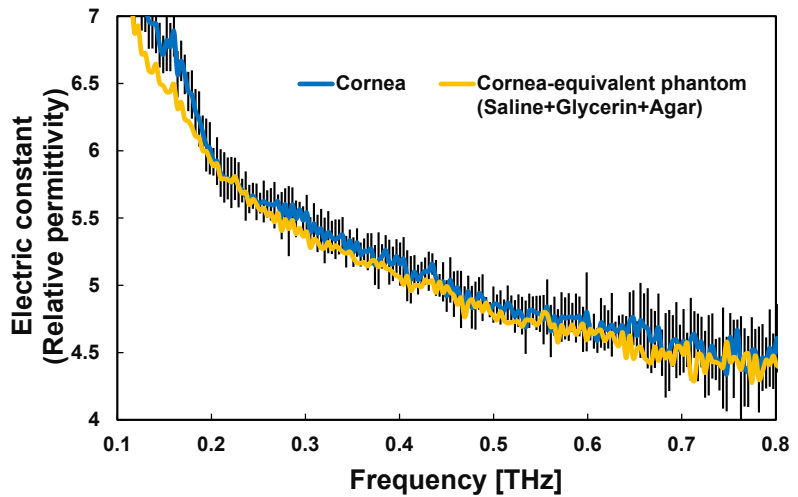

Fig.3 : Electric constants of the corneal tissue and the phantom

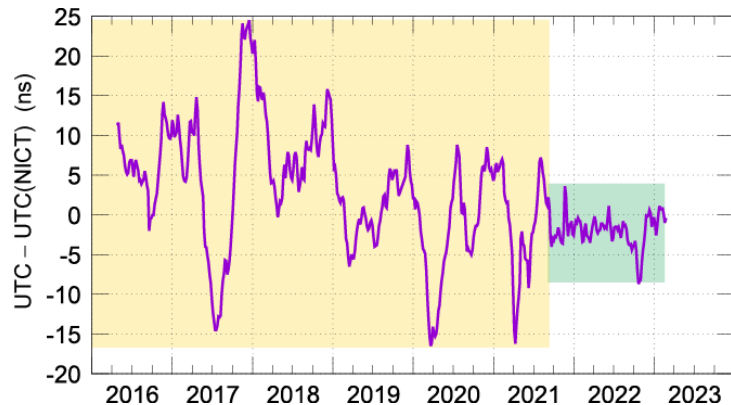

Fig.4 : The time difference of UTC and UTC (NICT) before and after introduction of frequency adjustment utilizing an optical lattice clock. Japan Standard Time is produced by adding 9 hours to UTC(NICT).

lene-stabilized lasers, we completed a portable 0.3 THz frequency standard with a frequency accuracy of 4.5×10^{-8} and a stability of 1×10^{-9} .

Applied Electromagnetic Research Center

At the Applied Electromagnetic Research Center, we mainly support research and development activities pertaining to digital optics technologies. We also promote exploratory and interdisciplinary research using electromagnetic waves and joint research and development with users

from different fields beyond the NICT mid-to long-term plan.

Digital optics technology

We developed a hologram printer which can manufacture two types of holographic optical elements (HOEs), the reflection type and transmission type, with one unit. Furthermore, as an example of an application of HOEs, we developed a transparent augmented-reality (AR) display enabling multiple people to observe 3D images of full color animations without 3D glasses at the same time with a horizontal viewing angle of 60 degrees (Fig. 5).

We installed an automatic design method for HOEs using machine learning in our laboratory's optical setup. Using two transmission type HOEs exposed with the hologram printer, we confirmed, in experiments, imaging characteristics that were almost the same as the theoretical values.

We also developed a natural light digital holography microscope that can perform precise optical measurements nearly ten times brighter than conventional methods with a compact optical system that does not require polarization filters.

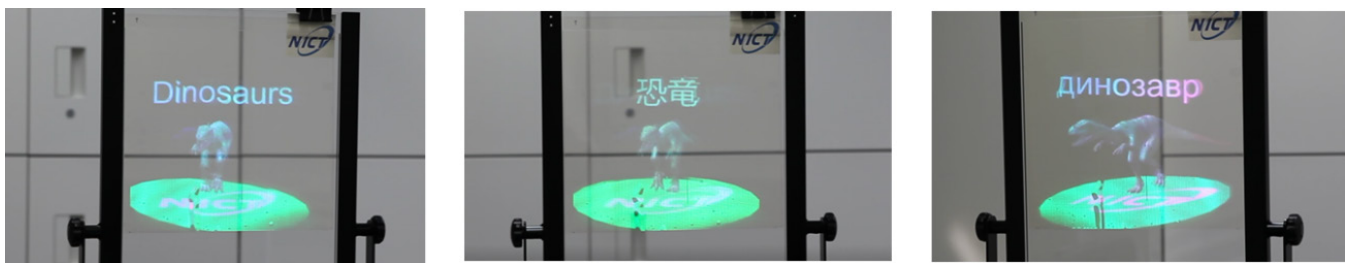

Fig.5 : 3D display of transparent full color animations with AR applications

Innovative Network Area Network Research Institute

Director General HARAI Hiroaki

In the Network Research Institute, we conduct R&D on "Innovative Network" technologies, which can respond to rapid growth in communication traffic, dynamic changes in communication quality, and various network services in order to realize the digital transformation of advanced social systems for Society 5.0 in the Beyond 5G era. We introduce recent R&D activities related to "Computing and AI-enabled Networking Technology", "Photonic Network Technology", "Optical and Radio Convergence Technology", "Next-generation Wireless Technology", "Space Communications Technology", "Sustainable ICT", and "Technologies for Enhancing Optical Network Resiliency". We also introduce our latest open innovation platform in the device field and international activities such as World BOSAI Forum held in Sendai.

Network Architecture Laboratory

Study on computing and AI-enabled networking technology

One of the research topics we have focused on is an information and attribute-based networking technology that utilizes a distributed information management mechanism. We proposed a user-centric

in-network caching function that facilitates fast and secure access to off-chain data storage managed by the blockchain technology through the integration of Information-Centric Networking (ICN) and Ciphertext-Policy Attribute-Based Encryption (CP-ABE) (Fig. 1). Simulation experiments confirmed that the download latency was reduced from 42.7 ms to 9.2 ms and the network traffic load was reduced to 1/40

compared to the existing approaches. These results were subsequently published in IEEE ICC 2022. Furthermore, we proposed an edge-based secure content distribution and retrieval scheme using ICN and Identity-Based Proxy Re-Encryption (IB-PRE) as a secure in-network content management framework. The proposed scheme allows the producer and the edge node to perform encryption and re-encryption of data in the network, thereby making it accessible to multiple consumers and reducing the communication delay by up to 36%. These research outcomes were presented in IEEE CCNC 2023.

As part of international standardization activities, the multicast protocol extension proposed in collaboration with U.S. router vendors was published as IETF RFC 9279 (Proposed Standard). In addition, the ICN name resolution requirements, in-network coding requirements, and in-network cache discovery mechanism were published in IRTF RFCs 9236, 9273, and 9344, respectively.

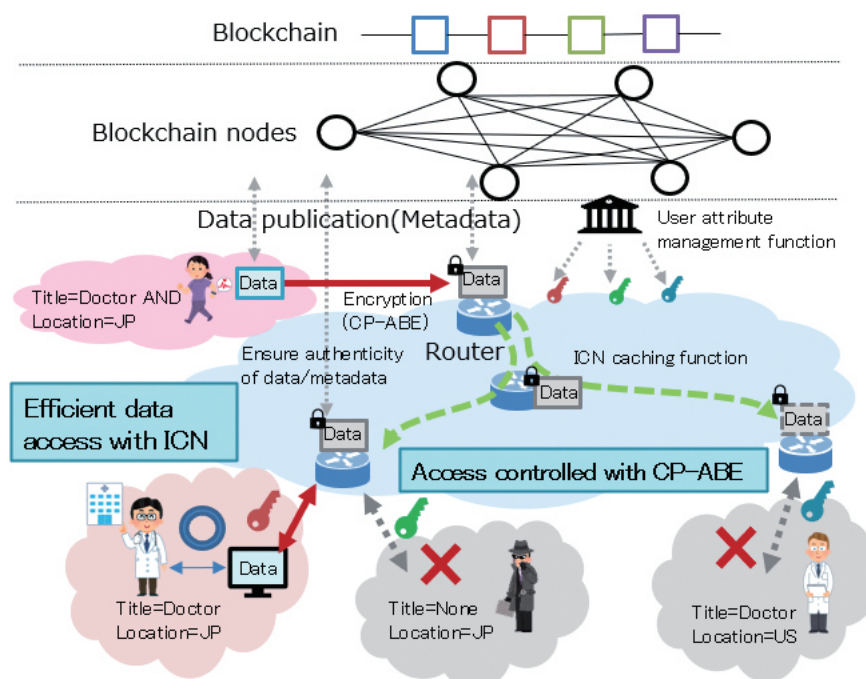

Fig.1 : User-centric in-network caching function using ICN and CP-ABE

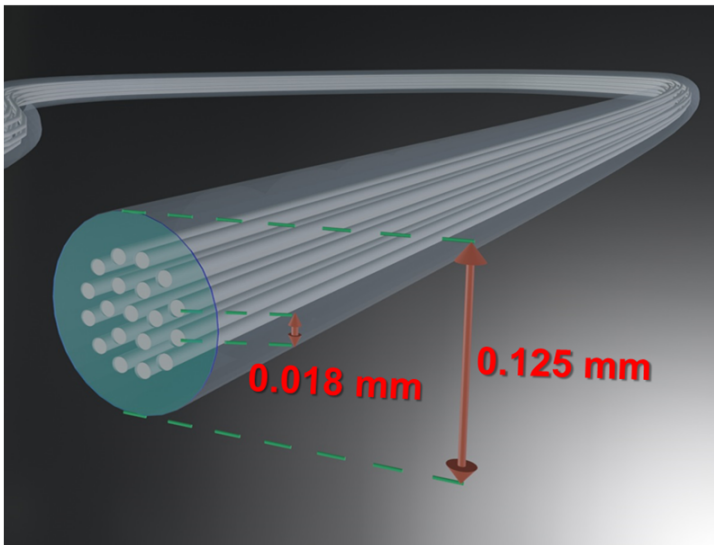

Fig.2 : Image of the developed 19-core optical fiber

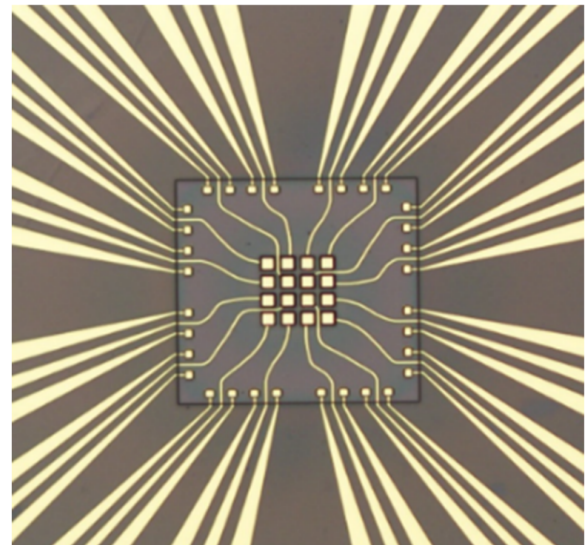

Fig.3 : The high-speed resonant cavity photodetector (PD) array

Photonic ICT Research Center

The Photonic ICT Research Center is engaged in cutting-edge research and development of technologies for ultra-high-capacity optical fiber networks utilizing the spatial and wavelength domains, technologies for using optical network resources more efficiently, and access technologies that integrate optical and wireless communications.

1) Photonic Network Technology

The Photonic Network Laboratory conducts R&D on ultra-high-capacity photonic networks to support the increasing data traffic. We have newly developed a randomly coupled 19-core optical fiber with a standard cladding diameter (Fig. 2) and demonstrated the recorded transmission experiment with a data-rate of 1.7 petabits per second over 63.5 km. We have achieved another remarkable transmission experiment of a data rate of 273.6 Tb/s over 1001 km with a 15-mode fiber.

Moreover, we have reported the first demonstration of spatial-super-channel switching in SDM meshed network with randomly coupled 4-core fibers which are field-deployed in L'Aquila, Italy. These results were accepted as postdeadline papers at the 46th Optical Fiber Communication Conference (OFC 2023).

2) Optical and Radio Convergence Technology

In the Optical Access Technology Laboratory, a flexible access technology is investigated from the viewpoint of devices and sub-systems to realize a seamless access network between wired and wireless networks.

In the research of massively integrated hardware technology, we fabricated a high-speed resonant cavity photodetector (PD) array (Fig. 3). Two wavelength division multiplex optical signals (25 Gbps NRZ) were transmitted by multi-core fibers and received with the resonant cavity PD array. As a result, 50-Gbps high data rate transmission was successfully achieved.

In the research of a harmonized seamless access system, the high-capacity transmission with a 32-Gb/s data rate has been successfully demonstrated with terahertz-wave at 285-GHz band by using cascaded radio over fiber systems.

These results were accepted as a top score paper and a postdeadline paper at OFC 2023.

Advanced ICT Device Laboratory

The latest open innovation platform in the device field

NICT is promoting R&D into challenging and innovative device technologies. The Advanced ICT Device Laboratory is an

open innovation platform in the device field which seeks opportunities not only for industry-academia-government collaboration but also domestic and international collaboration. We are conducting wide-ranging R&D into "device infrastructure," including applications in and basic science for the future ICT infrastructure, which will use all kinds of waves including optical and radio waves and quanta, and the social implementation of research outcomes.

In FY2022, 311 researchers from various institutions including NICT registered to use the facilities, and we counted a total number of 5,586 users in one year. We update the research apparatus and facilities to the latest version and are upgrading the device process and evaluation technologies. To contribute to R&D of Beyond 5G which NICT is promoting, we made the various equipment in our laboratory open to industry-academia-government contract research institutions for use as a testbed, and many of research institutions have already used them. The External Usage Program, in which we provide device processing and evaluating equipment together with device fabrication know-how, covered 15 processes previously, but we have now greatly expanded it to 27 processes, including those related to superconducting devices, etc. In this way, we contribute to creating new knowledge which will lead to technological seeds in the future industrial community.

Wireless Network Research Center

Looking ahead to the Beyond 5G era, we are globally scaling up three-dimensional seamless communications networks from the sea to outer space, combining non-terrestrial networks (NTNs) and terrestrial networks, and we are promoting R&D into wireless network technology that "connects" in all circumstances and environments.

1) Next-generation Wireless Technology

Concerning R&D into a wireless emulator simulating a radio wave system

in cyberspace, we held the Symposium on Utilization of Wireless Emulators on March 16, 2023 and contributed to informing people about its outcomes (Fig. 4). In addition, in the development of implementation technology for reflecting the behavior of real radio equipment in cyberspace, we investigated implementation technologies such as a software defined radio (SDR)-based 5G NR radio device, cyber-physical interface, and radiation pattern modeling of beamforming antennas and vehicle-mounted antennas for 5G/B5G. Our academic paper on the implementation technology for physical radio nodes won the Best Paper Award at WPMC 2022.

2) Space Communication Technology

For the realization of large-capacity optical communications with NTNs, we conducted an evaluation of the ultra-compact high-speed optical-communication device (breadboard model) we have developed so far, and completed an initial model (prototype model) for mounting on flying objects that increases transmission speed from 400 Gbps, which was the initial target of the current mid- to long-term plan, to a maximum of 2 Tbps transmission, which is five times as fast, using wavelength division multiplexing (WDM) to meet the growing demand for NTNs (Fig. 5).

Furthermore, we cooperated with the European Space Agency (ESA) to carry out a Japan-Europe joint experiment on satellite 5G integrated control, including geostationary satellite links. Using technology which links satellites and the ground using a 5G network, which is the outcome of this experiment, we aim to realize a three-dimensional network that connects multiple layers from the terrestrial to the sea, air, and space.



Fig.4 : Demonstration setup of SDR-based 5G NR system in symposium

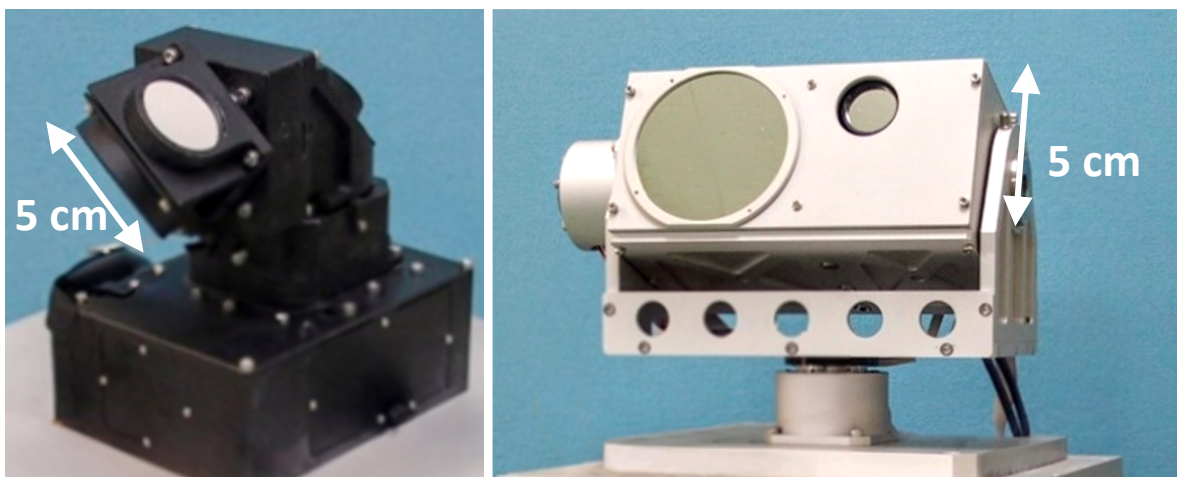

Fig.5 : Two types of prototype models of ultra-compact high-speed optical-communication equipment for mounting on flying objects

Resilient ICT Research Center

Resilient ICT Research Center was launched in FY2012 to carry out R&D into resilient ICT based on lessons learned from the Great East Japan Earthquake. In FY2022, we continued to engage in R&D into technologies for building an information and communications infrastructure which functions even in a tough physical space that experiences dynamic changes such as fragmentation and reintegration of the network due to large-scale disasters, failures, and other events, as well as R&D into resilient natural environment measurement technologies which detect sudden changes in natural phenomena. We also conducted R&D into fundamental technologies for enhancing the resiliency of optical networks and initiatives to encourage the social implementation of research outcomes through industry-academia-government collaboration for national resilience.

1) Participation in the World BOSAI Forum

This is an example of an initiative that

involved all the departments across the center. When the World BOSAI Forum, a cosmopolitan forum from Japan, which brings together representatives of industry, governments, academia, and the private sector from Japan and abroad in collaboration with the International Disaster Risk Conference in Davos, Switzerland (IDRC Davos), was held in Sendai in March 2023, we planned and held a session titled "Resilient ICT for Sustainable Society -R&D, Demonstration, and Deployment-" with the objective of holding exchanges with experts in the field from Japan and abroad and fostering new initiatives for the social implementation of resilient ICT (Fig. 6).

2) Sustainable ICT

For the building of information and communications infrastructure in a tough physical space, we engaged in the development of radio wave propagation prediction technology using camera images for quantification of circuit disruption risk and non-regenerative low-latency relay communications technology for the establishment of backup circuits, and conducted

the functional verification of technology which makes information and communications resources available even in an autonomous decentralized environment. Furthermore, we engaged in activities aimed at realizing resilient natural environment measurement technologies, including implementing real field experiments on highly weather-resistant and power-saving modules equipped with wireless communications functions which take into account power source independence.

3) Technologies for Enhancing Optical Network Resiliency

Optical networks experience not only hardware failures, such as optical fiber breaks, but also failures caused by specific physical phenomena. We are therefore advancing R&D into telemetry technologies for the early detection and prediction of potential sources of breakdowns and other issues, and into control upgrading technologies for maintaining network performance.



Session-06

Resilient ICT for Sustainable Society -R&D, Demonstration, and Deployment-







-  **Opening Remarks, Dr. Masugi INOUE**
-  **Resilient Private Communication System for Local Information Sharing, Dr. Yasuhiro OWADA**
-  **Integration of Artificial Intelligence (AI) and Internet of Things (IoT) for Disaster Resilient Smart Cities, Ir. Ts. Dr. Mau-Luen THAM, UTAR, Malaysia**
-  **Visual IoT: A Resilient Natural Environmental Measurement Technique, Dr. Ken T. MURATA**
-  **Electronics and Computer Technology for Resilient Community - Demonstration and Development Cases in Thailand, Dr. Kanokvate TUNGPIMLRUT, NECTEC, Thailand**
-  **Infrasound Sensing for Disaster Management, Dr. Ryouichi NISHIMURA, NICT, Japan**



Fig.6 : World BOSAI Forum

Cybersecurity Area

Cybersecurity Research Institute

Director General MORIAI Shiho

Countermeasures against increasingly sophisticated and complex cyber attacks have become an urgent issue for Japan as a whole. Under the Fifth Medium to Long-term Plan, which started in FY2021, the Cybersecurity Research Institute is working on the five items shown in Fig. 1.

Cybersecurity Technology

1) Development and expanded external use of next-generation STARDUST

We have developed an agile environment construction tool that can dynamically modify the logical and physical configuration of the STARDUST Cyber-attack Enticement Platform. We have also developed a new user interface that realizes high-speed and easy analytical work. These developments have enabled STARDUST users to perform more efficient analyses. We are working on improving STARDUST and also promoting its external rollout. The number of organizations using it has expanded to a total of 18 institutions.

2) Installation of the CURE data enrichment function

We have newly combined two types of data into the Artifact Layer of the Cybersecurity Universal REpository (CURE). Moreover, we have installed and commenced regular operation of an Enricher that provides additional information to the data stored in CURE to enhance the quality of the data. Furthermore we have developed CUREFlow, an intrusion detection system that detects abnormal communications by matching the IoC stored in CURE with NetFlow at high speed, as the CURE utilization system.

3) Upgrading and linking with multiple engines of a range of AI engines

In collaboration with National Taiwan University, we have developed FINISH, a technology capable of early detection of malware activities by learning (federated

learning) the darknet observation data observed by each party without sharing the raw data (Fig. 2).

Security Fundamental Technology

1) Continual federated learning by DeepProtect using bank data (Fig. 3)

In collaboration with a start-up launched by Kobe University, we conducted a test operation of the unauthorized use detection engine inside partner banks to see if it could identify the accounts of the victims in the previous fiscal year. We also implemented a demonstration experiment concerning continual learning for generating the unauthorized use detection engine. Regarding federated learning that realizes differential privacy, we have proposed an

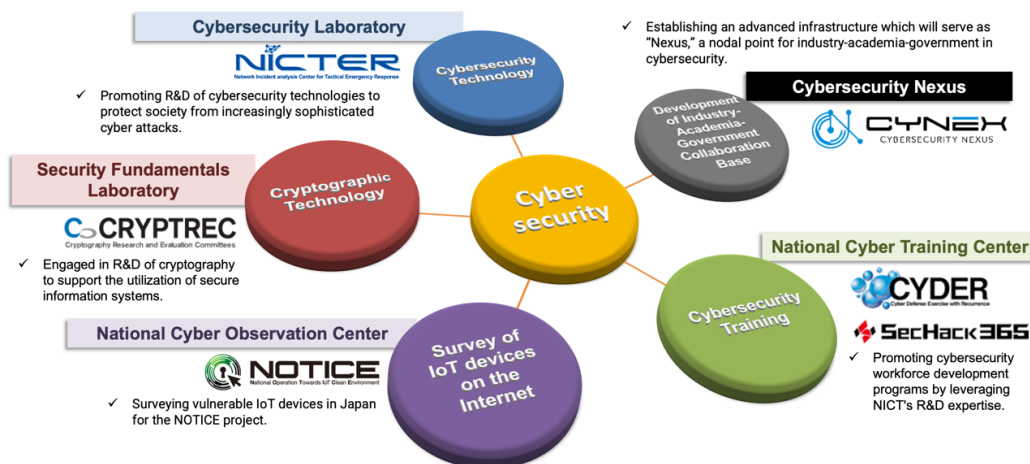

Fig.1 : Mission in Cybersecurity Area

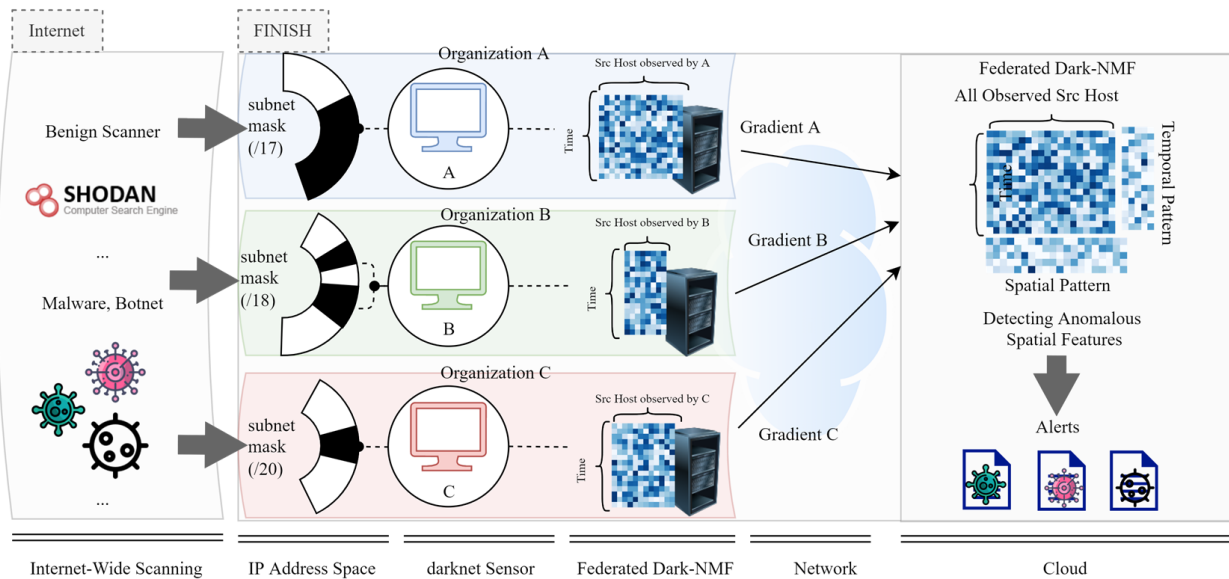

Fig.2 : FINISH: Federated Learning of Darknet Observation

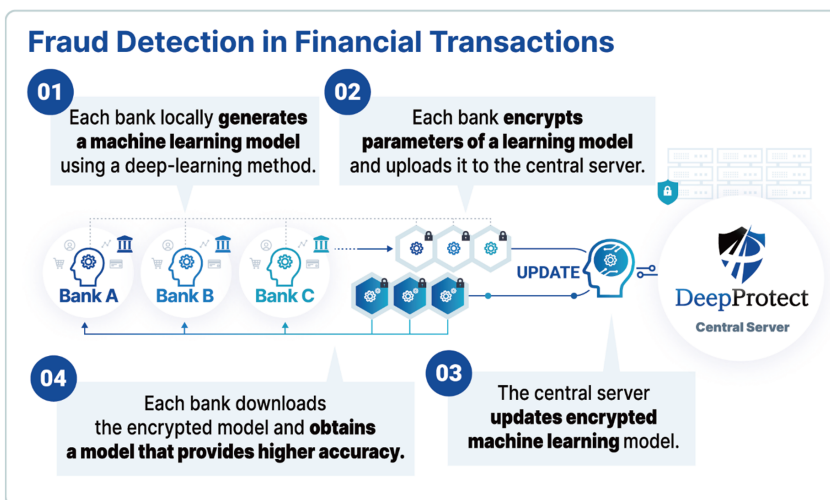

Fig.3 : Federated Learning using DeepProtect

algorithm for privacy-preserving federated learning that is capable of learning from the data of multiple organizations, while qualitatively protecting each organization's data privacy from the others.

2) Storage and chat system using searchable encryption

Our paper on system design and implementation evaluation was selected for the International Conference on Enterprise Information Systems (ICEIS) 2022. Furthermore, we built a trial use website for the general public. In collaboration with the University of Electro-Communications and the University of Tokyo, several results were accepted to international conferenc-

es. In particular, our paper on an attribute-based encryption scheme where trapdoors enable us to check whether two ciphertexts are encryptions of the same message received the Best Paper Award at the International Conference on Provable and Practical Security (ProvSec 2022).

3) Cryptanalysis of the Rocca authenticated encryption scheme for beyond 5G systems

In joint work with NTT, NEC, and Nagoya University, we demonstrated that our attack could break the security claim of the initial version of Rocca. Then, we presented an effective countermeasure to ensure its security claim. After reporting this

countermeasure to the Rocca designers, they quickly revised the specification, and the revised version of Rocca is available now. Moreover, the Rocca designers proposed Rocca-S as a similar type of Rocca, which employs the proposed countermeasure, and submitted a draft version of the Rocca-S specification to the Internet Engineering Task Force for standardization.

4) Cryptanalysis of the ZUC-256 stream cipher for 5G systems

In joint work with the University of Hyogo, we first developed new techniques with the tools of modular difference, signed difference, and XOR difference. Then, we applied the new techniques to the ZUC-256 initialization phase and improved the previous best attack by carefully controlling the interactions between these operations defined over different fields. Consequently, our work contributes to the upgrade of the ZUC-256 specification.

5) Evaluating threats of quantum computers to modern cryptosystems

In collaboration with Keio University, Mitsubishi UFJ Financial Group, and Mizuho Financial Group, we conducted experiments to evaluate the hardness of a discrete logarithm problem using quantum computers. We proposed a quantitative measure to determine whether an experiment on a quantum device succeeded in solving the problem.

Cybersecurity Nexus

1) Hardware infrastructure and establishment of a system for the industry-academia-government collaboration center

We have completed the design, procurement, and construction of the necessary hardware infrastructure equipment for the industry-academia-government collaboration center. Furthermore, we have built a large-scale parallel cyber attack analysis environment, a large-scale aggregated database of a wide range of cybersecurity-related information, a security device test environment, and security human resources development infrastructure, etc., onto this infrastructure equipment. We have also built resilient data accumulation infrastructure, including geographical dispersion, and an exercises infrastructure that enables the implementation of many different kinds of exercises at a high frequency.

2) Promotion of the activities of the four sub-projects Co-Nexus A/S/E/C

Cybersecurity NEXUS is a new department we established in FY2021 as a core base (NEXUS) of industry-academia-government collaboration, including on cybersecurity-related information analysis and human resources development, for contributing to the constant improvement of Japan's cybersecurity capabilities and continuously developing security human resources throughout society (Fig. 4). We have utilized the R&D outcomes of the Cy-

bersecurity Laboratory to consolidate a wide range of cybersecurity-related information on a large scale, and then established a platform for performing cross-cutting and multifaceted analysis of this information and generating practical and explainable threat information. We are providing the generated threat information to the concerned institutions, which require it on an ongoing basis. Additionally, we are using this platform to create environments in which domestically-produced security technologies developed by domestic equipment manufacturers and system operators can be verified, and we are giving feedback on the verification results.

National Cyber Training Center

The National Cyber Training Center was established on April 1, 2017 as an organization which plans and promotes practical cyber-related training by entirely using the technical knowledge, research outcomes, and research facilities of NICT. The Center comprises the Cyber Training Business Promotion Office and the Cyber Training Laboratory, and they closely collaborate with each other to implement the Cybersecurity Operator (Practical Operator) development project and the Cybersecurity Innovator (Innovative Researcher and Developer) development project, which are cybersecurity and ICT human resources development projects, while carrying out related research and development (Fig. 5).

1) Cybersecurity Operator development project

In the Cybersecurity Operator development project, we are implementing two practical cyber defense exercises using actual computers: CYDER (CYber Defense Exercise with Recurrence) and the practical cyber exercise RPCI (Response Practice for Cyber Incident). The objective of these exercises is to develop cybersecurity operators within certain organizations, such as administrative institutions and private companies, that have the incident response capability to respond immediately when the organization to which they belong suffers a serious cyber attack, or in other words in an "emergency." Regarding CYDER, following on from the previous fiscal year, we have implemented group exercises more than 100 times across all 47 prefectures in Japan in FY2022 as well. As a result, the cumulative total number of participants since the exercises first began in FY2013 has surpassed 19,000 people and CYDER has grown into one of the largest cybersecurity exercise programs in Japan. For the practical cyber exercise RPCI, a course that commenced in FY2021 for renewal of the Registered Information Security Specialists (RISS) qualification, we have endeavored to adapt the schedule to the needs of the participants, for example by holding the exercise ten times a year including twice on a Saturday, and holding it twice in the month immediately before the registration deadline for qualification renewal. As a result, we achieved

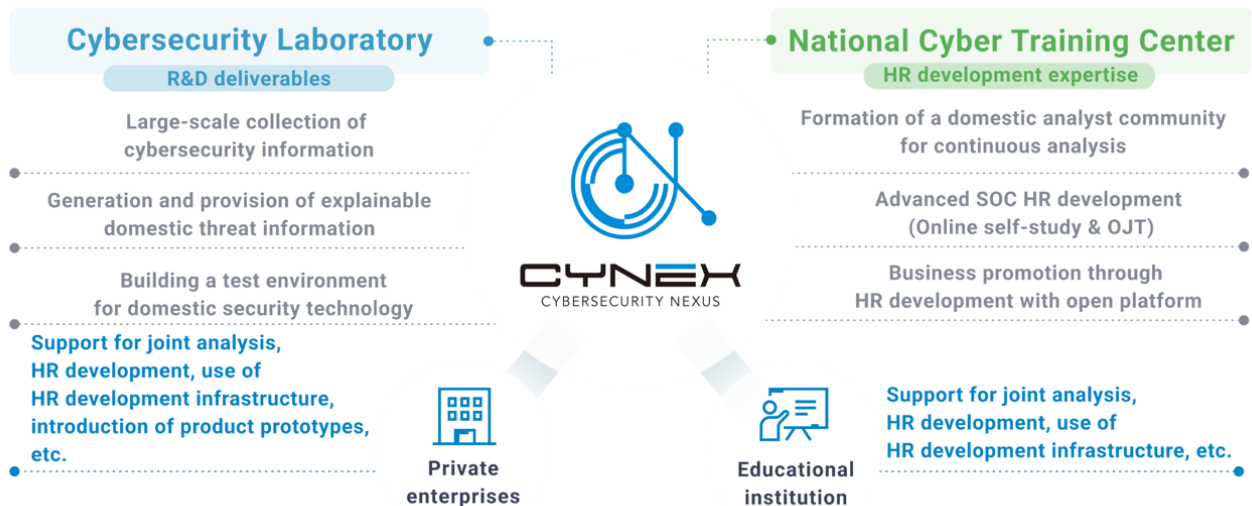

Fig.4 : Function of Cybersecurity Nexus

3.8 times the number of participants as the previous fiscal year and a high level of satisfaction among the participants. (48% of the participants answered "extremely satisfied," the highest rating in the five-grade evaluation.)

2) Cybersecurity Innovator development project

In the Cybersecurity Innovator development project, we have been offering SecHack365 to participants from FY2017, with the objective of developing high-level human resources who have a security mindset and the ability not only to use existing tools but also to research and develop innovative security software and other tools. In FY2022, 40 people selected

from among the applicants participated, and we held events a total of six times. Taking into account the COVID-19 situation, we held group training events off-line for the first time in three years, and provided more opportunities for participants to present their works and receive detailed feedback.

National Cyber Observation Center

Survey of IoT devices and the initiative to alert users (NOTICE)

"NOTICE" (National Operation Towards IoT Clean Environment), a project to survey vulnerable IoT devices and to alert users to the problem started on February 20, 2019,

by the Ministry of Internal Affairs and Communications (MIC) and the National Institute of Information and Communications Technology (NICT), in cooperation with internet service providers (ISPs), notified ISPs of a total of 48,814 cases warranting alerts in FY2022. Alerts were sent from each ISP that received the notification to the owners of the devices (Fig. 6). As of March 2023, the number of Telnet/SSH cases warranting alerts has declined approximately 30% compared to the peak time (December 2020).

The progress of the surveys is published every month on the NOTICE website (<https://notice.go.jp/status>).

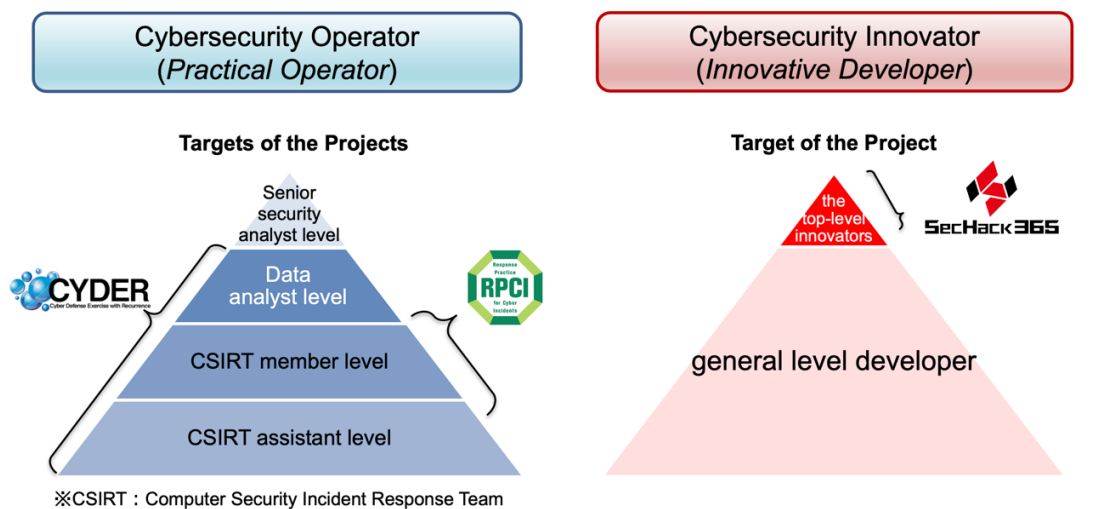

Fig.5 : Activities of the National Cyber Training Center

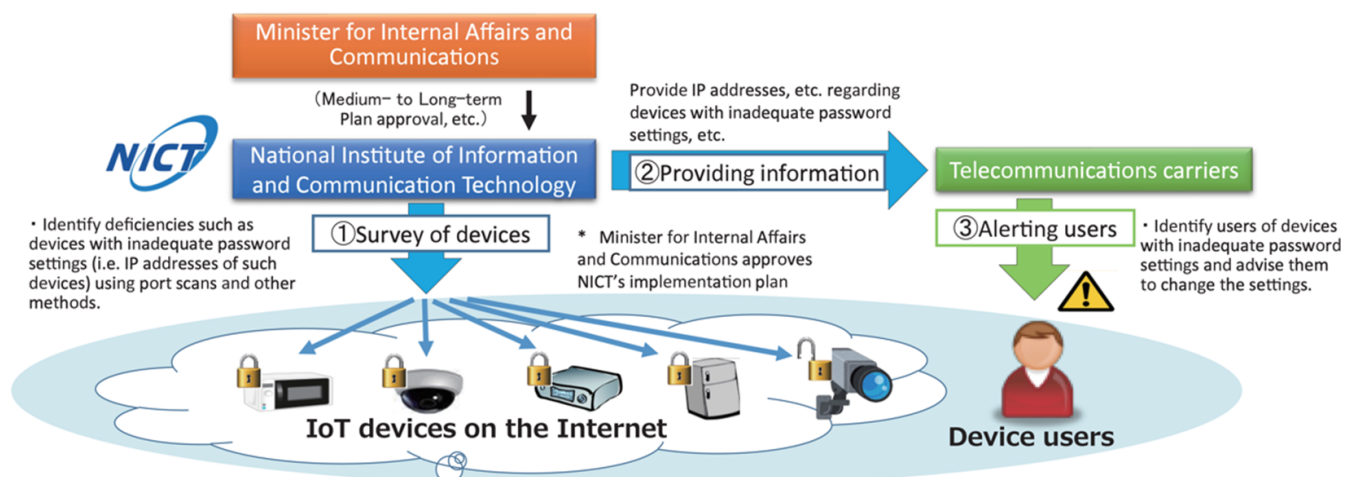

Fig.6 : Outline of NOTICE

Universal Communication Area

Universal Communication Research Institute

Director General UCHIMOTO Kiyotaka

The Universal Communication Research Institute (UCRI) aims to achieve universal communication that anyone can understand. By leveraging advanced technologies such as deep learning using massive amounts of data including speech, text, and sensor data, we are researching and developing multilingual communication, social knowledge communication, and smart data utilization infrastructure technologies. We are also promoting social implementation of systems that support diverse user interfaces. Through these initiatives, UCRI seeks to help solve a variety of social problems using ICT and create new value in society towards the Beyond 5G era.

R&D of Multi-Language Communication Technologies

Based on the Global Communication Plan 2025 (March 31, 2020, Ministry of Internal Affairs and Communications)¹⁾, we are advancing the following measures to realize practical implementation of automatic simultaneous interpretation. We are aiming to develop (i) split point detection for input speech and other technologies that enable integration of external processing, such as summarization, with translation, in order to realize low-latency automatic simultaneous interpretation; (ii) translation technologies which allow transmission and receipt of information from multiple fields and languages using Japanese only; (iii) technologies that can minimize the dependency on bilingual data; (iv) technologies which increase the translation accuracy by taking into account information besides the sentence itself (the context, the speaker's intentions, and the surrounding situation, etc.); and (v) evaluation technologies of automatic simultaneous interpretation. Furthermore, in order to steadily advance social implementation, we are (vi) accumulating a large volume of bilingual translations using our Hon'yaku (Translation) Bank to realize multilingual automatic translation that can be used in wide-ranging fields; (vii) building bilingual corpora for spoken language for the priority languages for which it is necessary to

improve the translation quality of daily conversations, including travel, medical care, disaster prevention, to a practical level; (viii) developing speech recognition technology, and language identification and speaker recognition technology with a practical level of accuracy that enables automatic transcription of speech from lectures and meetings in business and international conferences for top priority languages such as Japanese, English, Chinese, etc.; (ix) developing technologies that synthesize natural, human-like speech in order to smoothly transmit the translation results, etc., and technologies which control voice quality, such as a speaking speed that reduces the deterioration of naturalness as much as possible; and (x) expanding the target languages for speech recognition and speech synthesis of daily conversation. In parallel with these measures, we are making the underlying technologies for automatic simultaneous interpretation technology publicly available and

implementing them in society as well.

Regarding (i), using data derived from chunks, which are translation units shorter than a sentence, and from the simultaneous interpretation process, we have expanded the language pairs that can be divided into chunks using deep learning beyond Japanese-Chinese, the pair specified in the fiscal year plan, to include also the Japanese-Korean, Japanese-Vietnamese, and Japanese-Taiwanese pairs as well. Moreover, we expanded from English-Chinese to also include the English-Korean, English-Vietnamese, and English-Taiwanese pairs and confirmed the delayed compression effect. Furthermore, in order to limit the deterioration of translation quality resulting from chunk division, we improved the technique so that the previous translation unit is also considered during the translation process. We also increased the number of languages for which we offer translation using sentence unit division and completed the technology transfer to-

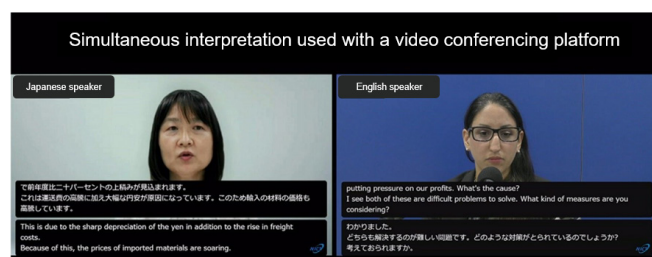

Fig.1 : Simultaneous interpretation system used with a video conferencing platform

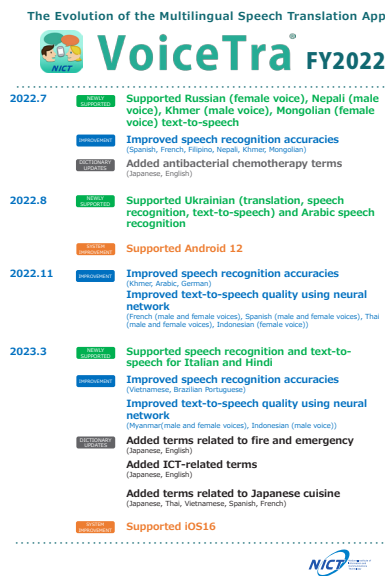

Fig.2 : Evolution of VoiceTra

gether with the ones available for chunk unit division. We expanded the chunk unit data languages from Japanese to the four languages of Indonesian, Filipino, Brazilian Portuguese, and French.

Regarding (viii), by FY2022, we built a speech corpus of a total of about 3,000 hours centered on the Japanese, English, Chinese, and Vietnamese languages and achieved a practical level of recognition accuracy (a level at which the results of speech recognition contain minor errors but can be read and understood sufficiently) in Japanese and an almost practical level (a level at which the results of speech recognition contain errors but can be read and understood to some extent) in English. Concerning the language identification technology, with respect to the issue that the identification accuracy deteriorates significantly when acoustic features differ between speech data to be used for identification model training and real speech data, which is the target of identification, we devised the Transducer-based language embedding method that allows modeling of linguistic features (features of a chain of phonemes) in addition to acoustic features. As a result, the identification error rate for a two-second speech almost halved (from 17.7% to 9.31%). Regarding (ix), we are improving the sound quality of the neural speech synthesis method and have developed an end-to-end model that

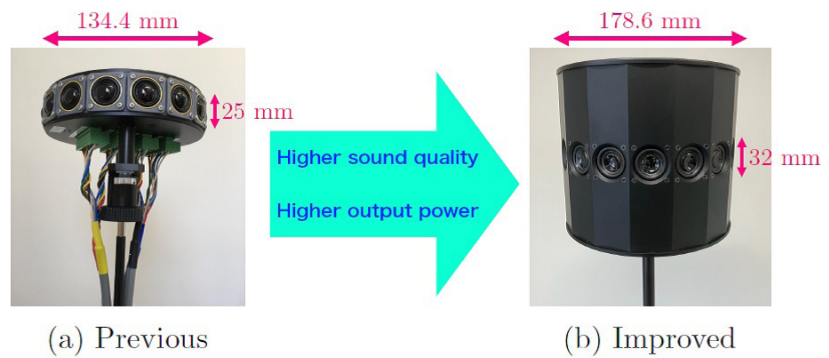

Fig.3 : 16-loudspeaker circular array (left: prototype, right: upgraded loudspeaker system)

uses a single neural network to directly generate the speech waveform from a sequence of context labels, which is the result of the language analysis. Consequently, we realized sound quality improvement (the Mean Opinion Score (MOS) value improved from 4.0 to 4.3) while also reducing the learning time by more than half.

In addition, we have improved the speech recognition accuracies for five important languages (Russian, Arabic, Hindi, Italian, and German) in fields such as economic security much earlier than planned and released them in VoiceTra. Moreover, in response to a request from the Japanese government, we added Ukrainian to VoiceTra in a very short period of four months as an urgent initial response for refugees from Ukraine. We also implemented technology transfer for all of these (Fig. 2) while the utilization of NICT's voice translation technology continues to expand in various fields.

Multiple Sound Spot Synthesis System

We are conducting R&D into a multiple sound spot synthesis system that uses multiple loudspeakers to simultaneously synthesize different sounds in different areas. When there are multiple output languages in simultaneous interpretation, a problem arises whereby the translations in the different languages get mixed together in normal loudspeaker playback, making it hard to distinguish what is being said. Multiple sound spot synthesis can address this issue by transmitting different sounds to each area, so it is an important technology

in the R&D into simultaneous interpretation technology and multilingual communication. In FY2022, we developed a prototype capable of transmitting synthetic sounds in four directions in the four languages of Japanese, English, Chinese, and Korean using a circular array of 16 loudspeakers. In December 2022, we implemented a demonstration experiment at the National Museum of Emerging Science and Innovation (Miraikan), and we exhibited a four-language multiple sound spot synthesis system in the G7 Digital and Tech Ministers' Meeting in Takasaki, Gunma, held in April 2023 and the 2023 IEEE International Conference on Acoustics, Speech, and Signal Processing (ICASSP 2023) held in Greece in June 2023. Furthermore, in March 2023, we newly developed a loudspeaker system that improves sound quality and sound volume (Fig. 3), and at the NICT Open House event in June 2023, we unveiled to the general public a four-language simultaneous interpretation system for Japanese, English, Chinese, and Korean, which is integrated with multiple sound spot synthesis (Fig. 4). Moreover, in October 2023, we realized an eight-language (Japanese, English, Chinese, and Korean + French, Spanish, Russian, and Arabic) synthesis system, which doubled the number of languages and number of domain divisions (Fig. 5), and we demonstrated it at the Keihanna R&D Fair 2023, the Internet Governance Forum 2023, the CEATEC 2023, and the IEEE Workshop on Applications of Signal Processing to Audio and Acoustics (WASPAA 2023) held in New York.

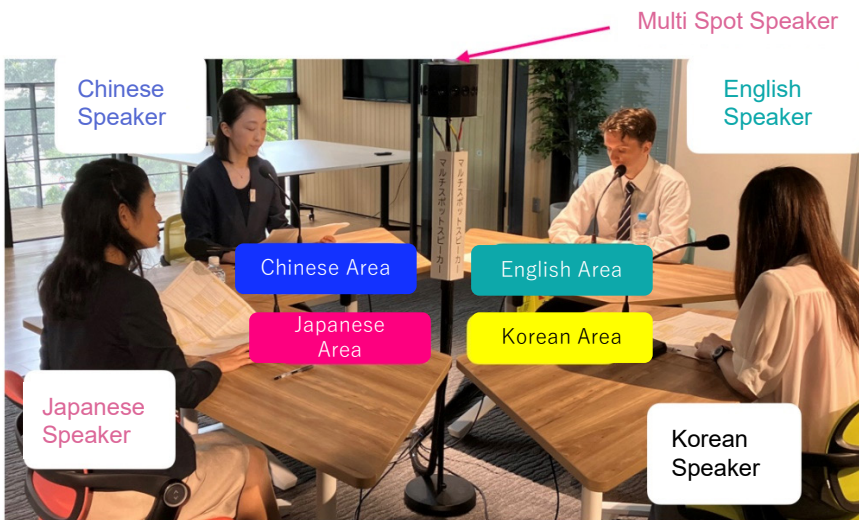

Fig.4 : Four-language simultaneous interpretation system using a multiple sound spot synthesis loud-speaker system

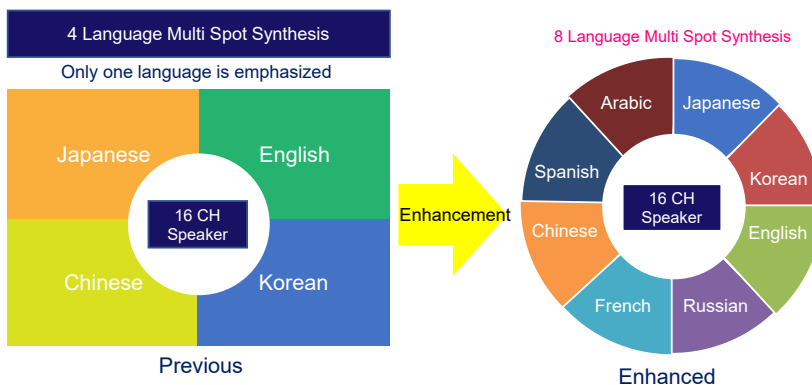

Fig.5 : Four-language multiple spot synthesis (left) and eight-language multiple spot synthesis (right)



Fig.6 : The experiment being implemented in Hidaka Village, Kochi Prefecture, during which conversations were held every day for 15 days
Video available at <https://www.youtube.com/watch?v=cuIHPYEqOKc&t=75s>

Data-driven Intelligent Communication Technology

We have expanded RaNNC, automatic parallelization deep learning middleware, greatly reducing the amount of memory necessary when learning. RaNNC won the Minister of Economy, Trade and Industry Award in the 35th Awards for Advanced Technologies that Generate Innovation. Furthermore, we prepared the world's largest amount of learning data to be used for hypothesis generation using knowledge of semantic relations between sentences, in order to develop a groundbreaking new method which generates several hundred non-obvious new hypotheses when key words designating the input sentences and directions of the hypotheses are given. Regarding the Multimodal Interactive Care Support System (MICSUS), we conducted a large-scale demonstration experiment involving 179 elderly people from across Japan (Fig. 6), in which we held 927 conversations consisting of 26,704 utterance turns (the elderly subjects made 12,885 of the remarks) and conducted objective evaluations of approximately 13,000 utterances, the largest scale in Japanese. As a result, we were able to confirm its high accuracy in interpreting the meaning of users' utterances in health condition checks, achieving 93.5%, and also in the appropriateness of all of the system responses, including chit-chat responses, achieving 92.9%. Moreover, we confirmed results that suggest that MICSUS could ameliorate the issue of limited communication opportunities for elderly people. For example, 25% of the elderly people smiled at the chit-chat responses during the demonstration experiment and more than half showed an active interest.

R&D of Platform for Smart Data Analytics Technology

We have developed a new cross-modal attention model for our cross-data analysis, greatly improving its performance, and winning the ACM Multimedia Grand Challenge on Detecting Cheapfakes. We have worked to demonstrate the use of the MM sensing information asset for an operation management application in collaboration

with a transport company, realizing a substantial improvement in the performance of driving risk event predictions, and proceeding to the point of considering an operation management digital transformation (DX) service, including an application for analyzing and visualizing risk trends for drivers and driving support for avoiding risks. Furthermore, we launched a development environment for systems that predict weather and environmental data from the Data Centric Cloud Service (DCCS), gained users who develop new applications and conduct demonstration experiments such as behavioral support based on risk predictions, and promoted expanded use of the research outcomes.

R&D of Advanced Reality Technology

We have developed REXR (Realistic and Expressive 3D avataR) technology, which constructs a realistic and expressive 3D avatar of an individual from images of a single camera and reproduces fine facial expressions and gestures in real time. Reproduction of facial expressions and head movements was done at 30 fps (delay: 33 ms), and when body motion was included, about 20 fps was achieved (delay: 200 ms depending on the degree of occlusion of body parts, etc.). To improve the accuracy of the reconstruction, we carried out machine learning using approximately 3 million publicly available face images (about 8,600 people with about 360 face images per person). Furthermore, to realize smooth remote communication using REXR in the future, we conducted validation experiments concerning the human factors of 3D avatar technology and derived the requirements for designing a natural shared space. In FY2022, a psychophysical experiment was conducted to quantify the impact of the placement of 3D avatars in the shared space on the "users' perceived sense of unity" and obtained experimental data for 40 subjects.

Contribution to Japanese Government AI Strategy

NICT ranked AI as one of its research areas that must be strategically promoted

and established the AI Research and Development Headquarters in UCRI. In collaboration with other research institutes within NICT such as the Center for Information and Neural Networks (CiNet) and the Strategic Planning Department, the AI Research and Development Headquarters promotes research and development of AI based on Japan's AI Strategy 2022² (decided by the Council for Integrated Innovation Strategy on April 22, 2023). It is also participating as a core center in the "AI Ja-

pan R&D Network" along with AIST and RIKEN and is engaged in a variety of activities including the dissemination of AI-related information. NICT also cooperated with the 3rd Japanese-German-French AI Symposium held in October 2022, with three NICT researchers taking the podium.

*1 https://www.soumu.go.jp/main_sosiki/joho-tsusin/eng/pressrelease/2020/3/31_1.html (in Japanese)
 *2 <https://www8.cao.go.jp/cstp/ai/index.html> (in Japanese)

- Developed a **cross-modal attention model** that increases the accuracy of predictions of correlations between the images and text expressing an event

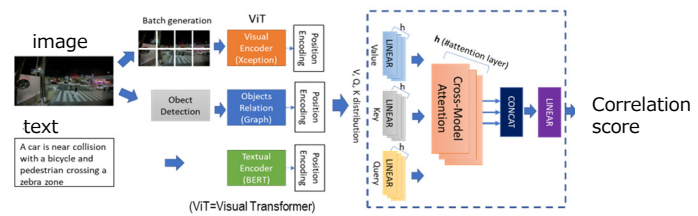

- In the ACM Multimedia Grand Challenge on Detecting Cheapfakes, we proposed two misleading caption detection methods based on the cross-modal attention model and won **first place and third place** among the participating teams



- Developed **FedProb**, a federated learning method that absorbs bias (Non-IID) in edge-collected data

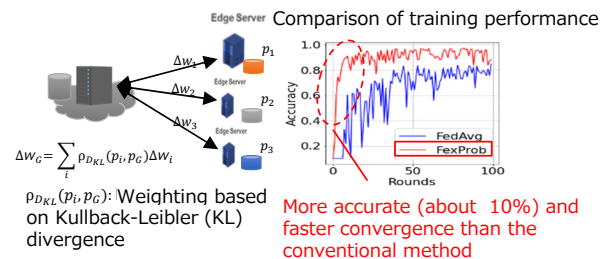

Fig.7 : Performance improvement of the cross-data analysis model and federated learning

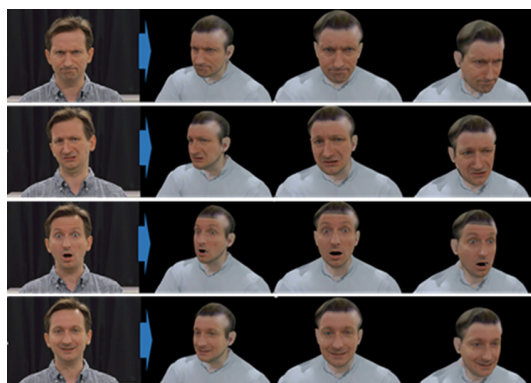

Fig.8 : Reproduction of various facial expressions in high fidelity on a 3D avatar using REXR technology

Frontier Science Area

Advanced ICT Research Institute

Director General WADA Naoya

With the spirit of cultivating the unexplored fields of the frontier with the plow of science without fear of failure, the Advanced ICT Research Institute is carrying out advanced and basic R&D backed up by sophisticated academic knowledge in order to pave the future of information and communications technology (ICT). The institute comprises frontier research centers in Kobe and Koganei, which are promoting R&D into devices based on new principles, and the Center for Information and Neural Networks (CiNet), based in Osaka.

In addition to R&D activities, it is promoting stronger industry-academia-government collaboration. As means of deploying research outcomes in society and contributing to the local community, the institute is also devoting efforts to participating in a variety of exhibitions, holding workshops and international academic conferences, and carrying out a variety of public relations activities.

Kobe Frontier Research Center

Superconductive ICT device technology

The Kobe Frontier Research Center is researching and developing multi-pixel technology essential to achieving a high-speed, high-performance superconducting nanowire single-photon detector (SSPD) with the aim of achieving an SSPD array on a scale of 200 – 300 pixels in combination with a superconducting digital signal processing circuit. The aim here is to demonstrate imaging with single-photon sensitivity. Furthermore, it is aiming to establish superconducting qubit production and evaluation technologies using nitride materials to improve the performance of superconducting qubits.

Organic-inorganic hybrid device technology

The center has been conducting studies into mass production of Si/organic electro-optic (EO) polymer hybrid optical modulators toward low-voltage and short-wavelength operation as fundamental technology for ultra-high-speed light control devices such as small-sized optical modulators, and studies into the means of optimizing their fabrication process. It has also prototyped and evaluated a 300-GHz-

band wireless light modulation device and advanced organic EO polymer stacking technology toward wideband and high-efficiency devices as fundamental technology for ultra-wideband electromagnetic-wave control devices such as wireless light modulation devices and electric-field sensors, succeeding in the fabrication of an organic EO polymer film stack of over 100 μm , and succeeding in using this to detect ultra-wideband electromagnetic-waves. Working towards realizing practical use, the center has clarified the photooxi-

dation mechanism of light control devices using organic EO polymer and carried out verifications of the light durability enhancement technology and its effectiveness.

Biomaterial technology

The center will build the fundamental technology for measuring and evaluating information associated with molecules, such as the chemical senses of living organisms and the impact of bioactive substances, for which measurement and trans-

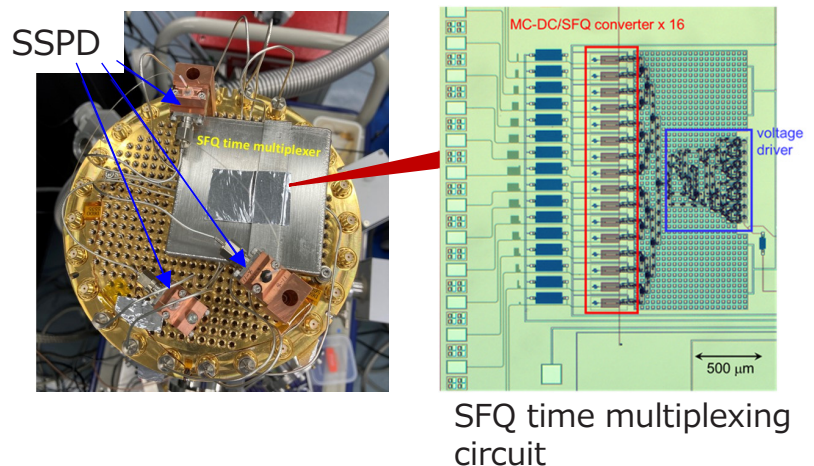

Fig.1 : Inside the refrigerator of the multi-channel SSPD system that uses SFQ time multiplex readout

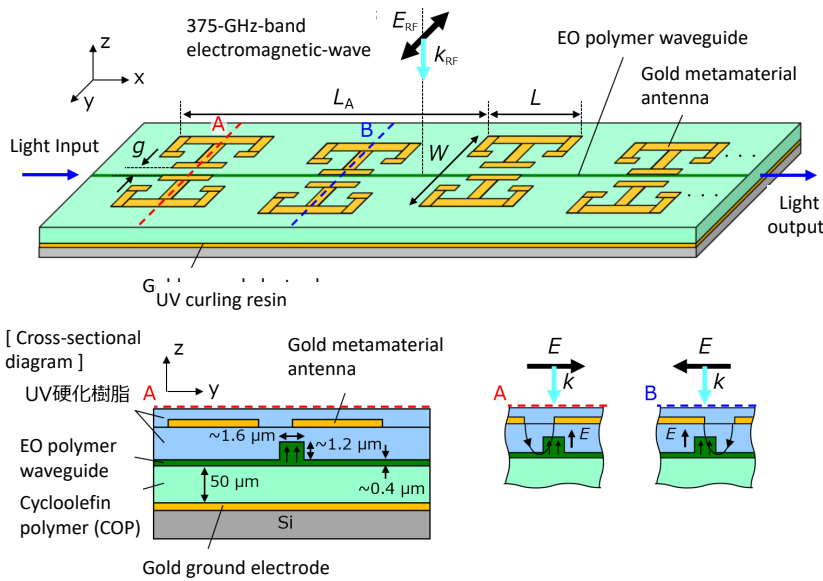

Fig.2 : A 375-GHz-band light modulation device possessing a metamaterial antenna array

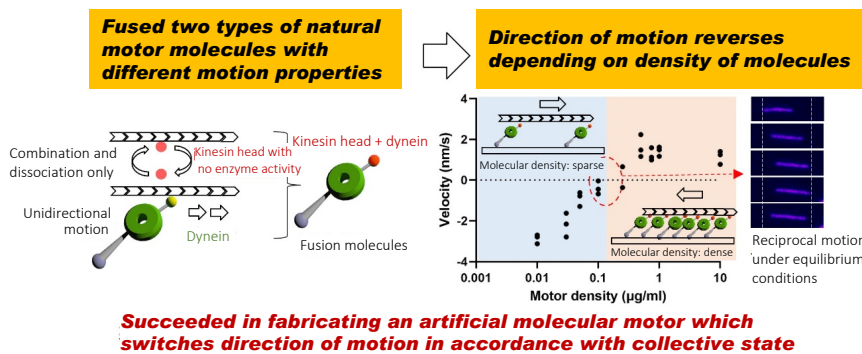

Fig.3 : Creation of a molecular motor which autonomously switches the direction of motion

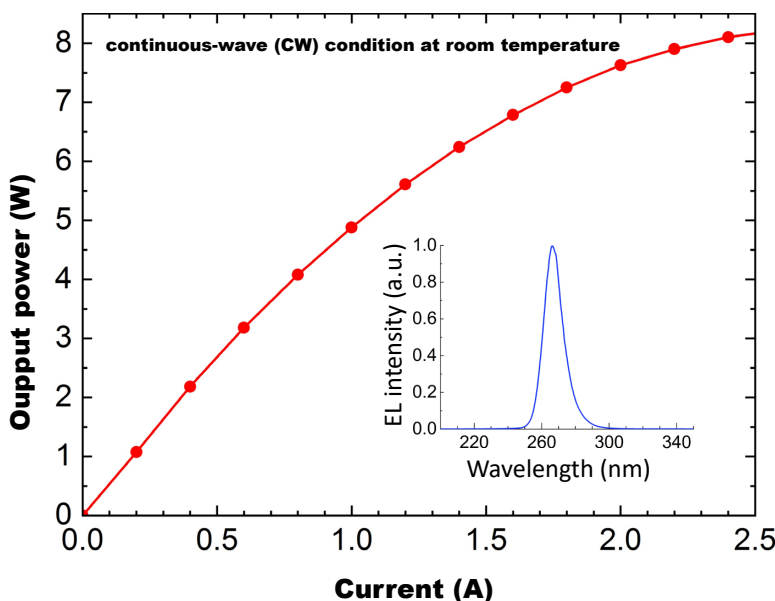

Fig.4 : Light output power and emission wavelength characteristics of the deep-ultraviolet LED handy irradiation machine

mission is difficult with existing ICT. It aims to develop fundamental technology for fabricating and operating novel information devices that utilize soft materials, such as biomaterials, which are necessary elements for the configuration and control of ICT systems that are based on the molecules that are universal to biological systems. The center designed and prototyped a mechanism for autonomously inverting the transport direction in the molecular shuttles, which transport information, and confirmed that the direction of motion actually reverses depending on the collective state (Fig. 3).

New ICT technology learning from insect's brain

In order to conduct a multifaceted measurement and evaluation of the factors contributing to the efficient operation of insect brains from a variety of perspectives, ranging from molecules and genes to neural circuits and the behavior of individuals, the center prototyped and evaluated an insect behavior analysis system using virtual reality, and investigated methods for conducting a functional analysis of the neural networks that play a central role in the environmental responses of individuals. Furthermore, it investigated elemental technologies for methods of analyzing brain function changes related to memory formation.

Deep-Ultraviolet (DUV) ICT technology

We have successfully demonstrated the world's first deep-ultraviolet LED handy irradiation machine with a Watt-class high-power operation exceeding a light output power of 8 W. This accomplishment was made by employing the technology of a high-power deep-ultraviolet LED chip exhibiting an emission peak wavelength of 265 nm, which is the most effective wavelength for disinfection, and by developing a technology for the high-density mounting of multiple LED chips on a high heat dissipation mounting board (Fig. 4).

Koganei Frontier Research Center

Quantum Secure Network Technology

The Koganei Frontier Research Center carried out a proof of concept for the real-

ization of a quantum secure network and obtained the following six outcomes: 1) realized high-speed secret sharing processing exceeding 700 Mbps; 2) in the QKD network built with Toshiba Corporation and others, succeeded in tripling the distributing processing speed for 80 GB of genome data; 3) in collaboration with Kyoto University, Toshiba Corporation and others, installed the dedicated genome analysis server in the quantum secure cloud as a "reliable server" and established transmission and storage technology while guaranteeing information-theoretic security except for inside the server; 4) realized filtering processing of genome information unnecessary for genome analysis or medical treatment at more than 400 Mbps, and published the outcomes in Scientific Reports; 5) as a demonstration of a similar concept in the manufacturing field, succeeded in demonstrating the optimization of the design of Kyoto University's photonic laser using Keio University's next-generation accelerator, and issued two press releases; 6) just by applying secret sharing and transmitting enough data for one password without relay, succeeded in a demonstration of information-theoretically secure data relay on a quantum key distribution network comprising nodes that can be trusted with large amounts of data.

Ultra-high frequency device technology

In its R&D into Terahertz-band transceiver integrated circuit technology, the center developed a 300-GHz band receiver for wireless communications. The receiver chip was designed and fabricated using a 40-nm silicon CMOS technology, which is suitable for general adoption (Fig. 5 (a)). The receiver circuit, which adopted a mixer-first architecture, achieved low noise, low loss, and high conversion gain by devising ways to reduce the parasitic components as much as possible. The chip was flip-chip-mounted on a multilayer printed circuit board (PCB) with a built-in waveguide transition using double-resonant stacked patches, enabling connection with a WR-3.4 waveguide interface (Fig. 5 (b)). The developed CMOS receiver module achieved the highest wireless data rate of 76 Gbit/s with 16 QAM (Fig. 5 (c) (d)).

Ga₂O₃ device technology (Green device technology)

The center is conducting R&D into power devices made with the semiconductor material gallium oxide (Ga₂O₃), a material that NICT demonstrated, for the first in the world, could be successfully in transistor operation in 2011. Due to Ga₂O₃'s excellent material properties originating from its wide bandgap, its applications are not limited to power devices; it is expected that Ga₂O₃ applications could include wireless communications and signal processing in "extreme environments," such as high temperatures and harsh conditions,

where stable use over long periods of time is not possible for existing semiconductor devices. The center fabricated short-gate Ga₂O₃ MOSFETs having an (AlGa)₂O₃ back barrier, and evaluated their DC and RF device characteristics. As a result, the center succeeded in substantially reducing the drain current leakage to below 1 nA/mm, and obtained the excellent high-frequency device characteristics of a current-gain cutoff frequency (f_T) of 10 GHz and a maximum oscillation frequency (f_{max}) of 24 GHz for the Ga₂O₃ MOSFET with a gate length (L_g) of 150 nm (Fig. 6).

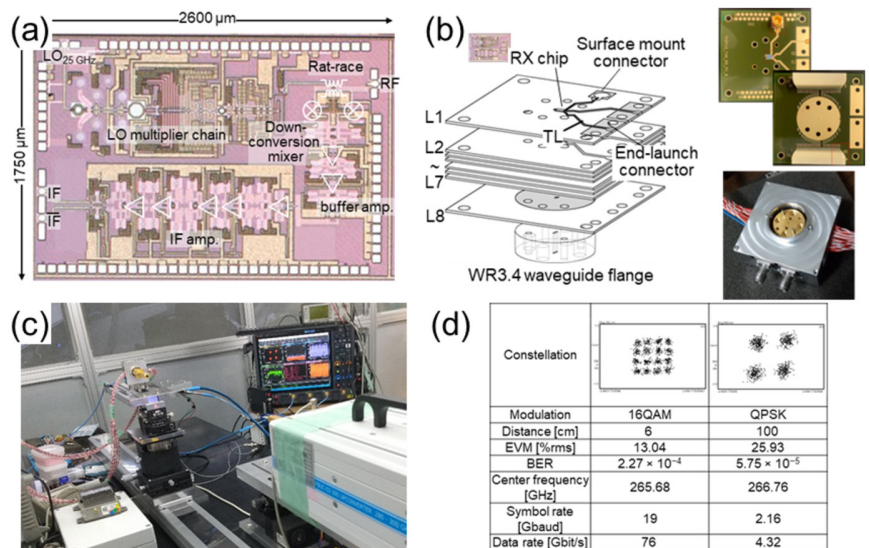

Fig.5 : 300 GHz-band CMOS wireless receiver

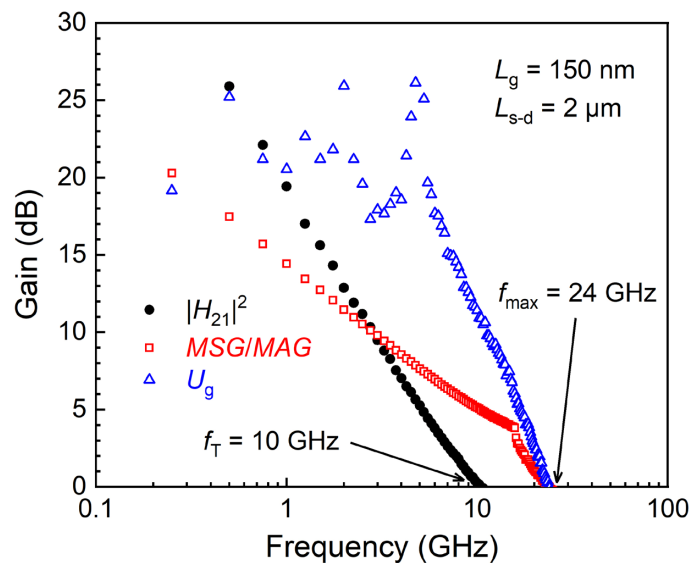

Fig.6 : RF small-signal characteristics of Ga₂O₃ MOSFET with an (AlGa)₂O₃ back barrier ($L_g = 150$ nm)

Center for Information and Neural-Networks

R&D on measurement/analysis of brain functions for constructing an artificial brain model

Aiming to develop technology that adjusts the sense of time using sensory stimuli, etc., the Center for Information and Neural-Networks has obtained new findings regarding the context-dependence and versatility of expressions of time within the brain. The mechanism for expressing time is the same regardless of the different types of stimuli, such as intervals and durations, but the center showed the possibility that the nerve cell groups expressing time are independent. Furthermore, the center conducted research to gather brain activity and behavioral data from subjects executing tasks that entail social interaction to predict the behavioral choices and reaction times of the subjects from their brain activity, and succeeded in quantifying the information contained in the initial dip of the amygdala BOLD signal measured by 7T-MRI, demonstrating the possibility that this could be used effectively in the decoding of facial expressions. The center used 7T-MRI to become the first in the world to measure the activities of the primary olfactory cortex, which is known to represent odor perception, at the high resolution of 1 mm square, and when it verified a change in odor perception due

to an odorous substance and a change in odor perception due to verbal labelling, it showed that the two changes are segregated inside the primary olfactory cortex. Besides research using large measuring equipment, the center also advanced research concerning brain information in daily life, which is different from a laboratory environment, and succeeded in building a model that estimates subjects' mental states from their brainwaves when they are listening to the news. Moreover, it proceeded to identify long-term mood indicators and measure brainwaves with the aim of developing this research into a model that takes into consideration the inter-day variation of mental states.

R&D on expanding application of brain information communication technology

The center discovered that hyper-adaptation is occurring in the brain of a wheelchair racing Paralympian, whereby the use of the foot section of the motor cortex in the motion of hands, and even expansion of this foot section, could be seen. Furthermore, the center revealed that the inter-hemispheric inhibition between the left and right motor cortex that is normally observed in the average person was not observed in the brain of this Paralympian. Rather, interhemispheric facilitation between the left and right motor cortex that is optimal for the bimanual coordination essential for wheelchair races was occur-

ring (Fig. 7). In addition, the center has built three-dimensional ultrasonic imaging (3DUS) combining two-dimensional ultrasonic technology and three-dimensional motion capture technology to make the world's first measurements of the complex muscle shapes of the shoulders, producing outcomes that have great potential for social implementation. For example, it demonstrated that there was no systematic error compared to MRI measurement, the standard method.

Industry-academia-government collaboration for enhancing social acceptance of brain ICT

The center made efforts to broadly inform the industrial world about CiNet's research outcomes and actively advanced joint research with companies. Furthermore, as part of ethical, legal and social issues (ELSI) efforts to gain social acceptance for its brain function research and the outcomes, the center has advanced attempts to clarify the commonalities and differences in the perspectives of researchers and ethicists. Furthermore, in the "AI technology estimating perceptual information from brain information" project currently being implemented under PRISM in the Cabinet Office, the center conducted survey research concerning the social acceptability of such technology and held a symposium to deepen discussions for its social implementation.

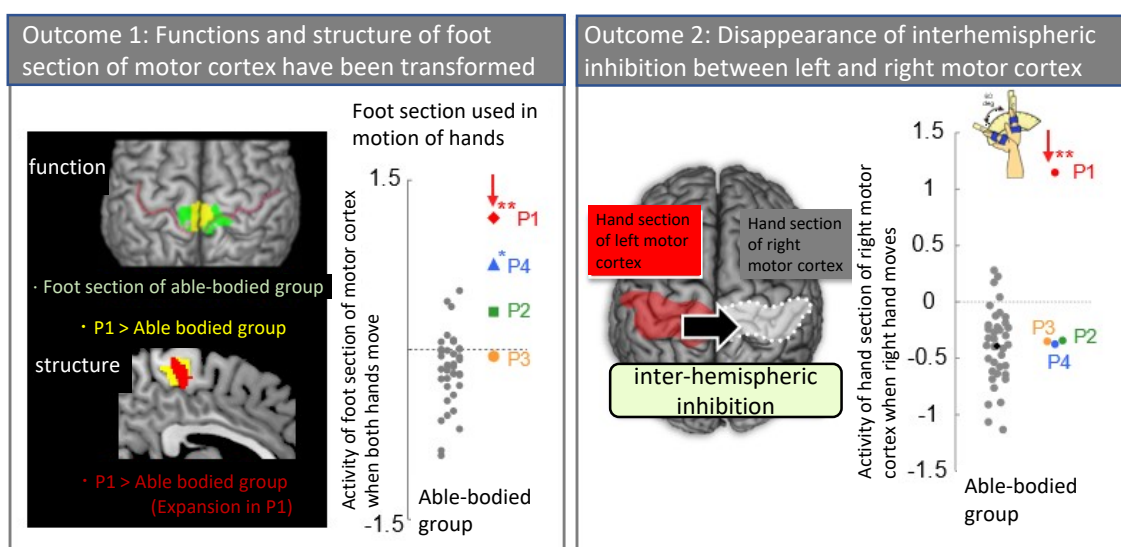

Fig.7 : Specialization of functions and structure seen in the brain of a top Paralympian in wheelchair races (P1)

B5G Field

Beyond 5G Research and Development Promotion Unit

Executive Director of Unit HOSAKO Iwao

The Beyond 5G Research and Development Promotion Unit is aimed at strongly promoting NICT's R&D into advanced elemental technologies for the realization of Beyond 5G/6G. It promotes effective information transmission through cooperation structures and a shared mindset inside the institute, formulation of strategies concerning the policy for collaborating outside the institute, and branding and system demonstrations. It also carries out R&D concerning the concept and architecture of Beyond 5G/6G, which will connect different industries to generate new value.

In FY2022, we implemented initiatives for realizing open collaboration. For example, together with our laboratories, we have jointly advanced discussions concerning a Beyond 5G architecture, which can provide forums for open creation, and reviewed demonstration systems for the exploration of new services.

Beyond 5G Architecture

Concerning the Beyond 5G architecture, which enables the gathering and appropriate combination of CPS functions, we have fleshed out the details of the "orchestrator and enabler" functions and the requirements for the integrated use of terrestrial and non-terrestrial networks in "heterogeneous network collaboration" and "digital twin linkage," through several rounds of discussions with our laboratories and others. We have reflected the outcomes of those discussions in the White Paper Version 3.0 (released on March 31, 2023). Furthermore, we have advanced the conceptual design of the necessary functions in the NICT testbed, a platform for collaboration with external partners (Fig. 1).

Collaborative Activities on Beyond 5G

In the 1st Beyond 5G Zero-Gravity Event, mixed teams comprising members from different industries discussed the possibilities for Beyond 5G from new perspectives, made a new human network, and generated innovation. NICT's researchers gained insights about the potential for new value creation through collaboration with other industries. Together with the international R&D community, we have invigorated

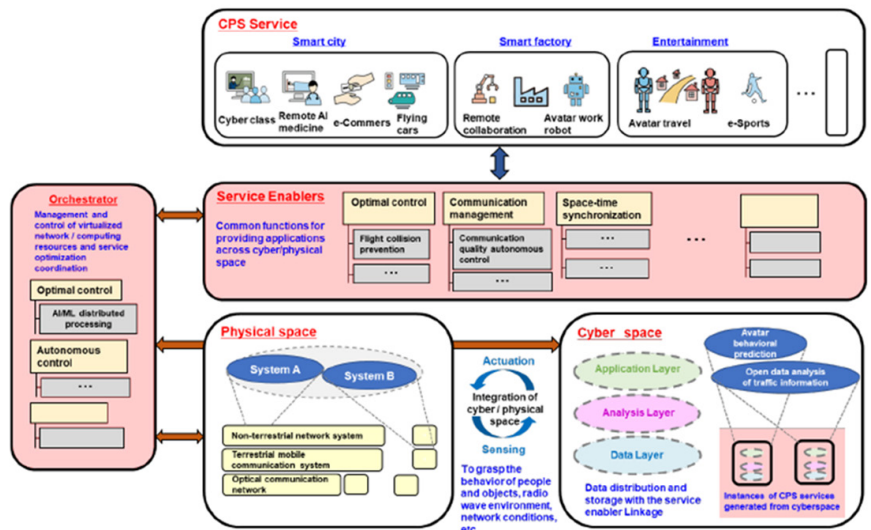

Fig. 1 : Functional Architecture of Beyond 5G/6G

R&D by advancing pioneering Beyond 5G initiatives, including through the conclusion of a Memorandum of Understanding with the University of Oulu in Finland (September 2022) and a joint announcement in an international academic conference with 6GEM, a large 6G-related R&D project in Germany (November 2022). At the Innovative Optical and Wireless Network (IOWN) Global Forum, we submitted documents about the importance, as an open platform, of the Beyond 5G architecture that we proposed in our White Paper and its functional configuration, and com-

menced discussions with the international R&D community. Furthermore, we developed a VR experience tool that enables intuitive understanding of the citizen life of a future society realized by Beyond 5G and the functions of the orchestrator, with the intention of using it at events such as exhibitions and lectures to involve external stakeholders from different industries. We published our White Paper online and publicized it broadly through lectures and a wide range of other activities. We also promptly published an English version, which was downloaded from the website

many times, leading to increased awareness of the necessity of the architecture, among other points.

Terahertz Wireless Communication Technology

To realize Terahertz (THz) wireless communications, we are developing THz signal transmission technology based on optical fiber communications technology, and in the current fiscal year, we constructed a radio-on-terahertz-over-fiber system applying Radio-over Fiber (RoF) technology for THz signal generation at the frequency of 300 GHz and more. In order to generate the THz waves, we used two lasers whose frequency difference was set to be in the THz band, and the THz waves were generated by using beat generation at an ultrafast photo-diode (UTC-PD). Here, we transmitted the data by modulating one of the lasers. Since the low noise characteristics are necessary for advanced multilevel modulation, we adopted SSB modulation for the laser modulation and succeeded in generating a THz signal with extremely

low noise of -100 dBc at a frequency offset of 10 kHz (>10 dB lower than before). With this configuration, we succeeded in transmitting at a distance of 4 m the THz waves at a frequency of 325 GHz carrying 5G NR-compliant signals (100 MHz 256 QAM and 400 MHz 64 QAM signals) (Fig. 2).

External Research Activities

As an application of Terahertz band electromagnetic waves, we are promoting the lunar orbiter satellite with onboard terahertz radiometer investigating surface water and energy resources named TSUKIMI (Lunar Terahertz SURveyor for Kilo-meter-scale Mapping) project as research commissioned from the Ministry of Internal Affairs and Communications. We proved from both sensor performance and the terahertz wave radiation transfer algorithm that surveying the subsurface water resources was feasible using terahertz-wave remote sensing. Moreover, we won the Special Judges' Prize in the S-Booster space business idea contest organized by the Cabinet Office (Fig. 3, left), and the

project organized industry-government-academia consortium, and held a public event at TeNQ (Fig. 3, middle). We have also developed an algorithm, named SNAP-CII, aiming to democratize remote sensing. The SNAP-CII algorithm estimates aerosol concentration, including PM2.5, from sky-photo data taken by commonly-used cameras, including smartphone cameras (Fig. 3, right). The accuracy is 70% for three class classification.

B5G Electromagnetic Wave Anechoic Chamber Facility

Like other parts of the world, there is growing momentum in Japan for research into the transmission technology for realizing further upgrades of the ultrahigh speed, ultralow latency, and extremely large number of simultaneous connections expected of Beyond 5G. There is, in turn, also a growing need for development of dedicated facilities, which can handle the ultrahigh frequency band. Therefore, we utilized NICT's research resources (people, technologies, and know-how) to develop a B5G electromagnetic wave anechoic chamber facility as a measurement environment to which wireless devices researched and developed by private companies can be introduced, with the objective of enabling quick feedback on development based on efficient evaluation of the device's performance and confirmation of its function. This anechoic chamber (Fig. 4) has a size of 20 meters deep, 8.5 meters wide, and 7.5 meters high and is equipped with a turntable, etc. The radio wave absorbent is fixed onto the ceiling surface and the side surfaces, and the absorbent on the floor surface can be laid and stored so use in a metallic floor surface state is also possible.

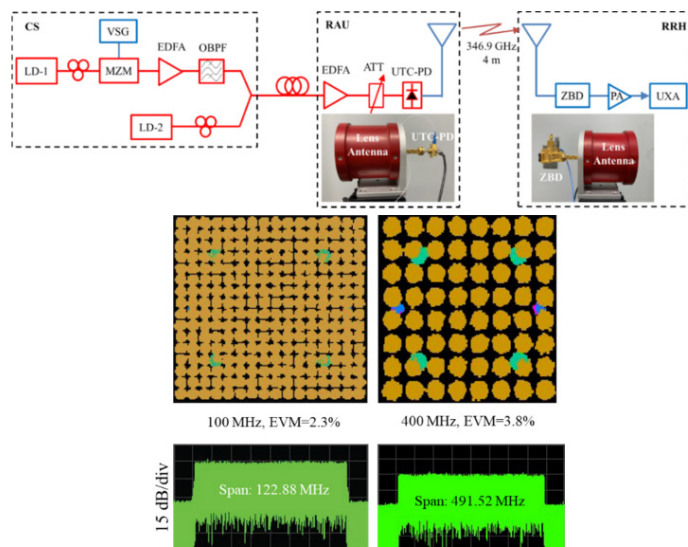

Fig.2 : Experimental setup of radio-on-terahertz-over-fiber system (top) and the received 256 QAM (100 MHz) and 64 QAM (400 MHz) signal (bottom)



Fig.3 : B5G Social Outreach Activities

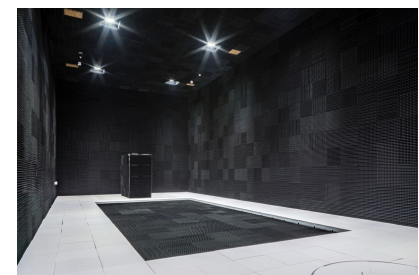

Fig.4 : Interior of B5G electromagnetic wave anechoic chamber facility

Quantum ICT Field

Quantum ICT Collaboration Center

Director General FUJIWARA Mikio

The classical physical constraints on which the existing communications technology supporting our advanced information society depend are starting to become apparent. It is predicted that a series of physical limits will eventually be encountered, such as the power density limit of optical fiber and the crisis of code-breaking using the latest technology. In order to overcome such limits, we are utilizing quantum mechanics, one of the laws of physics, and strategically advancing R&D, through our own research and industry-academia-government collaboration, into quantum cryptography technology, whereby information-theoretic security is ensured by the laws of physics, and into related physical layer security technology (quantum secure network technology). Furthermore, we are engaging open innovation and strategic ICT human resources development through the formation of a strategic and agile R&D hub.

Quantum Secure Network Technology

In the quantum key distribution network, a key relay method based on "trusted nodes" has been employed in the extension of the key distribution distance and expansion of the service area, and a quantum key distribution network based on this key relay method has been established in various countries around the world. In response to this, NICT is developing technology that lowers the required security level of the "trusted nodes" and guarantees the security of the key even if the nodes are under some kind of attack. Specifically, we have carried out the basic design and function verification for hyper-distributed network technology, which processes, transmits, and stores the encryption keys and data distributed across multiple nodes and links in order to up-

grade the quantum key distribution network and spread it over a wider area. At the same time, we have been also advancing the implementation and verification of the major functions for network control and management. In FY2022, we completed the basic design of the hyper-distributed network technology, combining random number masking, error correction encoding, and block division and distribution, and carried out a statistical evaluation of reliability, security, and availability with respect to node compromise to complete the function verification. We also designed a technique to reduce the consumption of one-time pad keys by introducing our original network encoding (Fig.1).

Furthermore, concerning control and management of the quantum key distribution network, we have developed a new Graphic User Interface (GUI) to upgrade and streamline state management, includ-

ing faults, link configuration, billing, and performance, and have implemented many network operation demos for government officials and important potential customers while advancing verifications to flush out problem areas and accumulate operational know-how. For the network testbed, we have advanced expansion and development to double the number of nodes and the number of links from the previous network by establishing new nodes in NICT's quantum security and collaboration building, as well as in government agencies and private companies. Furthermore, concerning satellite quantum key distribution and physical layer cryptography technology, we have completed the detailed design of the key management unit and network controller function to be mounted on satellites, and developed key management simulator software that simulates the action of link-

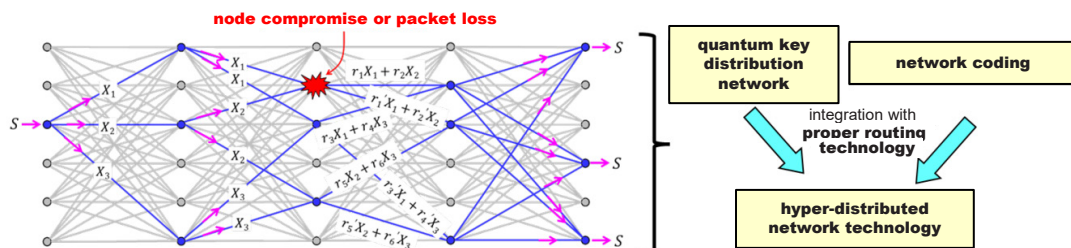

Fig.1 : Actual example of 1:3 multicast on a multipoint mesh network using hyper-distributed network technology

age with ground stations, with the aim of globalizing the quantum key distribution network. We have carried out the design and trial production of the receiving telescope on the ground side, the detailed design of the precision tracking optical system, and the detailed design and trial production of the quantum receiver.

Generating Open Innovation by Forming a Strategic and Agile R&D Hub

For the construction of a next-generation cryptography infrastructure, the Quantum Cryptography Communications Network Demonstration Project, part of the FY2021 supplementary budget, advanced the development of a quantum key distribution device, a high-speed confidential communications and secret sharing system, and a quantum/classical hybrid information processing device. We are constructing a testbed to allocate quantum key distribution devices to administrative agencies and private companies, among others, in Tokyo. In particular, we are making progress in the development of an environment that enables joint verification with multiple financial institutions and this environment constitutes the first network of its kind in the world. Fig. 2 shows the management console for the Tokyo QKD Network, which we plan to expand.

Strategic ICT Human Resources Development

In order to strengthen the international competitiveness of the ICT field in Japan, we established and provide a human resources development program that utilizes NICT's research outcomes, such as quantum technology. We provide it not only to the young researchers and technicians who are responsible for the future of Japan but also to instructors and other educators, thereby contributing to the development of highly specialized human resources who can open up new ICT domains. Specifically, in order to develop the human resources who will shape quantum ICT, most notably quantum computation and quantum communications, we are conducting R&D into quantum technology

outside NICT, inviting researchers and developers involved in applications to serve as lecturers and advisors, and implementing hands-on human resources development using seminars and exercises and exploring/problem-solving-type human resources development using R&D support, while also utilizing NICT's quantum ICT-related research outcomes and human resources. We continued to conduct NICT Quantum Camp (NQC), a program for developing quantum native human resources, in FY2022. As we have done through FY2021, we continued to implement the three programs of (1) open seminars for members of the general public interested in quantum ICT, (2) a hands-on program for selected members involving seminars and exercises with specialists, and (3) an exploring program implementing research under the guidance of a supervisor. We also held online exchanges among the hands-on and exploring participants. Seventy people participated in

(1); 55 people selected from 69 people participated in (2), with 41 people being certified as having completed the program; and four research projects (seven people) applied for (3), with four projects participating and receiving completion certification. We also implemented an initiative to get NQC graduates involved in the operation of NQC as "supporters." Through such efforts as encouraging the participation of graduates in the above online exchanges and holding supporter-led study sessions and events, we have established a mechanism in which human resources previously involved in NQC continue to educate each other and grow. Moreover, we launched the "Challenge laboratory for younger people" (seven people), and among the graduates, there were students who will participate in NICT's R&D as research assistants. In this way, we were able to generate human resources circulation (Fig. 3).

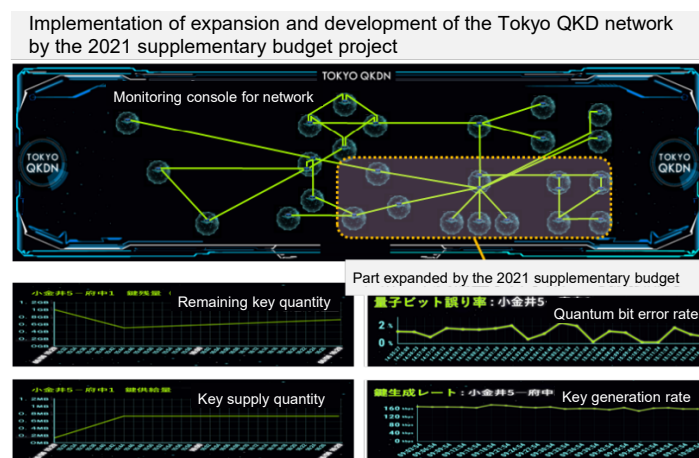

Fig.2 : Monitoring console for quantum key distribution network

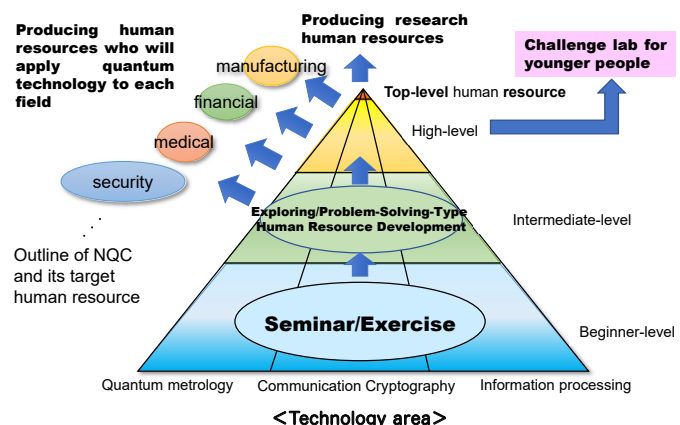

Fig.3 : Overview of the quantum ICT human resources development structure

Open Innovation

ICT Testbed Research and Development Promotion Center

Director General KOJIMA Fumihide

The ICT Testbed Research and Development Promotion Center is implementing the following measures for the realization of Society 5.0 in light of the continued development of new technologies, such as Beyond 5G, that is anticipated.

- On the existing testbeds in NICT, we are newly building a distributed wide-area verification environment and real-time emulation environment that can verify the social and technological needs of the Beyond 5G era and a verification environment for data utilization that contributes to the realization of a data-driven society. We are also supporting verification environments for global cutting-edge technologies such as optical and quantum communications technologies to contribute to R&D, technology verification, social implementation, and international collaboration in the ICT field of Japan.
- Through opportunities such as activities in the related forums and the R&D implemented by the Japanese government, we are contributing to new value creation and solutions to social issues by combining the R&D capabilities of testbed users such as NICT, Japanese and overseas research institutes, communications carriers, vendors, and startups in the testbed. In addition, we are making various efforts to develop an internationally appealing R&D hub, including the cyclical evolution of the testbed's verification environment through testbed use, operation, and improvement.

Developing a Beyond 5G/IoT Testbed with High-reliability and High-elasticity, Promoting its Use, and Ensuring its Cyclical Evolution

In October 2022, we commenced provision as planned of the Beyond 5G Reliable Virtualization Infrastructure, Beyond 5G Mobile Environment, and Data Centric Cloud Service (DCCS), the new Beyond 5G functions for the Beyond 5G/IoT Testbed with High-reliability and High-elasticity, which we are building as a testbed capable of verifying the social and technological needs of the Beyond 5G era. We have also made preparations for the general provision of the Cyreal Evaluation Environment from FY2023. Furthermore, we promoted activities from the following perspectives in order to ensure its effective use (Fig. 1).

International Collaboration using 100 Gbps International Lines

At SC22 (The International Conference for High Performance Computing, Net-

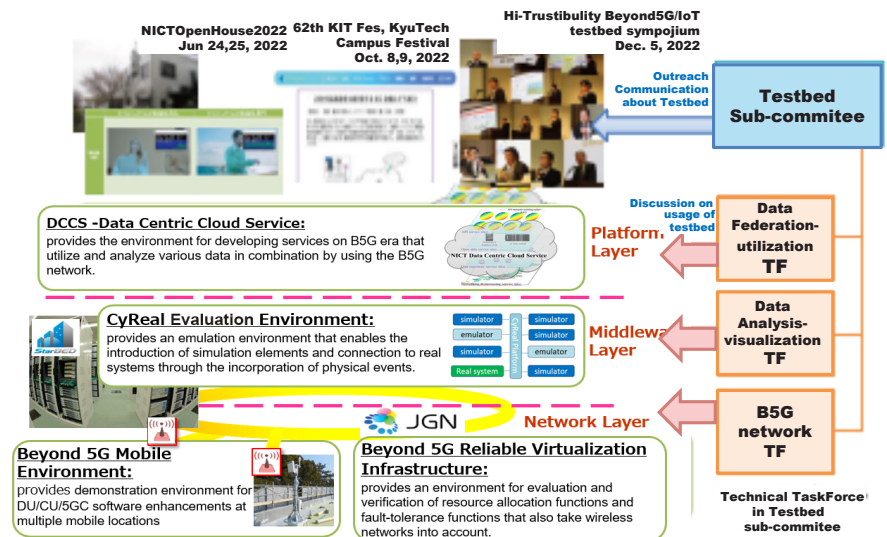

Fig.1 : Building and commencement of provision of the Beyond 5G/IoT Testbed with High-reliability and High-elasticity, and outreach to external users.

working, Storage, and Analysis: an international conference and exhibition held in the Kay Bailey Hutchison Convention Center in Dallas, Texas, the United States) in November 2022, we implemented six verification experiments, including a 400 Gbps E2E data and video transmission experiment using six 100 Gbps lines between Japan and

the United States, through collaboration and cooperation with Asia Pacific Oceania Network (APONet) members (Pacific Wave, TransPAC, University of Hawaii, Arterial Research and Educational Network in the Asia Pacific, Singapore Advanced Research and Education Network, National Institute of Informatics, Joint Universities Computer Cen-

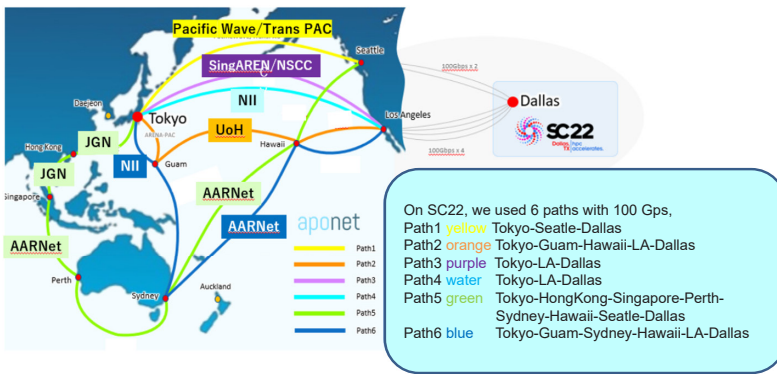

Fig.2 : The six 100 Gbps lines used in the SC22 international verification experiment



Fig.3 : Data visualization app example: Matsuyama City PLATEAU Building + LPWA (920 MHz) communications experiment visualization

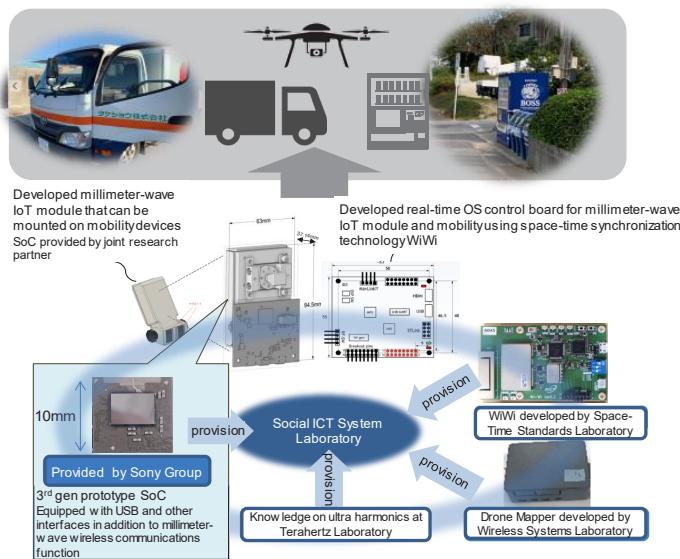

Fig.4 : An integrated communications verification system combining a cutting-edge 60 GHz millimeter-wave-band IoT communications device (SoC) with WiWi and NICT's space-time synchronization technology

tre, Australia's Academic and Research Network) (Fig. 2). APOnet and NICT each won a SCinet Spirit of Innovation Award, as an international framework and as an organization, respectively.

Test Production of the Data Analysis and Visualization Program for the Data-Driven Service

To contribute to the fundamental technologies for the development of GIS (Geographic Information System) space-time data apps inside and outside NICT, including DCCS, we completed the foundations of the GIS space-time data platform, as well as developed the database and access API, data visualization API, and web apps (25 types) and made these openly available (Fig. 3). Furthermore, we started

work on the GIS space-time data platform for DCCS and ported the foundations for the real-time video transmission service and for the IoT data storage and browsing service into the DCCS.

Building and Service Provision of the NICT Data Centric Cloud Service Layer Testbed and Beyond 5G Network Layer Testbed

Working with the relevant NICT departments, we enabled the use of DCCS as an effective testbed, including utilization in technology transfer projects and for NICT-commissioned research on R&D of advanced communications and broadcasting. Furthermore, we commenced service provision of the Beyond 5G Reliable Virtualization Infrastructure and the Beyond 5G

Mobile Environment as customizable mobile environments from October 2022.

Building the Cyreal Evaluation Environment

On StarBED, we rolled out the support software that we developed for building the Cyreal Evaluation Environment, which enables verification by linking simulations and emulations of physical events with real devices and software. In advance of this, we provided the environment to multiple partners and made improvements for general provision in FY2023, such as fixing bugs and incorporating requests.

Collaboration and Integrated Utilization of IoT Wireless Technology, AI Technology, Autonomous Service Robot Technology, and Space-Time Synchronization Technology across Different Fields and Industries

In collaboration with multiple companies and other partners across different fields and industries, we combined ultra-high-frequency IoT wireless technology, AI technology, autonomous service robot technology, and space-time synchronization technology, which will constitute the Beyond 5G society, and utilized them to implement activities to upgrade NICT's buildable data collection and distribution system and conduct proofs of concept under a collaborative framework that includes both the system developers and operators (Fig. 4).

Open Innovation

Innovation Promotion Department

Executive Director NAKAZATO Gaku

The Innovation Promotion Department collaborates inside and outside NICT to seek to maximize R&D results by fulfilling its mission as follows.

- Promote efficient and effective R&D and contribute to the strengthening of collaboration with government, industry, and academia by making effective use of external research resources through the collaborative research, commissioned research, and funded research schemes.*
- Contribute to the creation of open innovation through the implementation of R&D results in society by appropriately securing and effectively using intellectual property and participating in effective standardization activities through collaboration with government, industry, and academia.*

Promotion of Collaborative Research and Researcher Exchanges

NICT was involved in 514 collaborative research agreements in FY2022. Of these, a total of 107 new agreements were concluded, 101 in Japan and 6 overseas (Fig. 1). As a type of collaborative research, we have also been promoting “funded collaborative research” in which the collaborator provides NICT with research expenses. In concluding an agreement, we perform a supporting role by consulting with the research departments of concern, negotiating with the collaborating research institution, preparing an agreement template, upgrading an agreement-conclusion manual, and providing storage/search functions for related information.

As for researcher exchanges, we promoted the dispatching and accepting of

researchers and contributed to intensifying collaboration among government, industry, and academia by promoting mutual cooperation in the field of information and communications. Additionally, we promoted research exchanges with universities through a cooperative graduate school system by having NICT researchers give lectures at graduate schools and providing research guidance through the acceptance of research trainees.

Promotion of Commissioned Research

(1) Promotion of commissioned research on R&D of advanced communications and broadcasting

We promote efficient and effective commissioned R&D by making good use of external research resources for research themes that can be made more efficient by integrating them with NICT’s own research. In terms of research results, in FY2022, there were 100 papers 225 oral presentations, 109 standardization proposals and 35 industrial property rights applications (22 domestic and 13 international).

(2) Promotion of commissioned research on R&D of innovative information and communications technology

We are implementing “commissioned research on R&D of innovative information and communications technology” in the “Beyond 5G R&D Promotion Program,” which aims to strengthen Japan’s international competitiveness in Beyond 5G. In terms of research results, in FY2022, there were 381 papers 1,048 oral presentations, 144 standardization proposals and 570 industrial property rights applications (262 domestic and 308 international).

Promotion of the Acquisition and Appropriate Implementation of External Funding

We provided information inside NICT regarding a variety of research funding systems and offered support for the checking, advising, and administrative work pertaining to the application documents (over 100) to expand the acquisition of external funding. Furthermore, we enhanced the incentives for acquiring external funding by holding briefings on the application guidelines, etc., and seminars on the acquisition of grants-in-aid for scientific research, and by implementing the External Research Funding Acquisition Promotion System. The amount of external funding acquired in FY2022 is shown in Fig. 2.

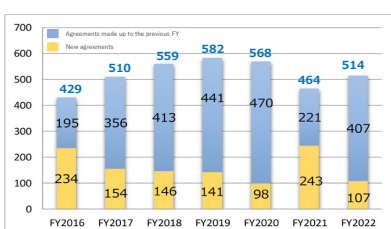

Fig.1 : Trends in number of collaborative research agreements

Proactive Acquisition and Use of Intellectual Property

The number of patent applications in FY2022 came to 141 (88 domestic and 53 international), while the number of registered patents held by NICT came to 1,041 (662 domestic and 379 international) as of the end of FY2022. Compared with the previous fiscal year, the number of domestic patent applications increased. On the other hand, we made progress in reviewing the registered patents held by NICT for cost reductions, so the number of registered patents held by NICT had decreased by the end of FY2022 (Fig. 3). The number of new technology transfer agreements came to 21, bringing the total number of the technology transfer agreements as of the end of FY2022 to 135. Technology transfer revenue in FY2022 came to 117.85 million yen, and the number of agreements and revenue from intellectual property increased compared

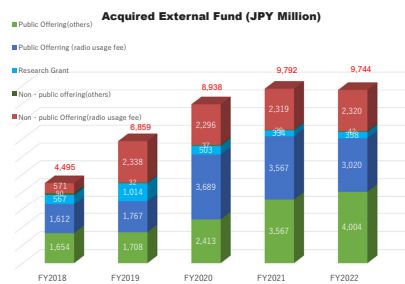

Fig.2 : Annual progress in obtained income from competitive research funds

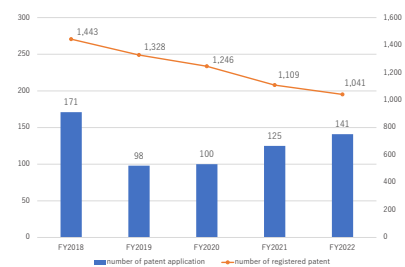

Fig.3 : Trends in patent applications and registered patents

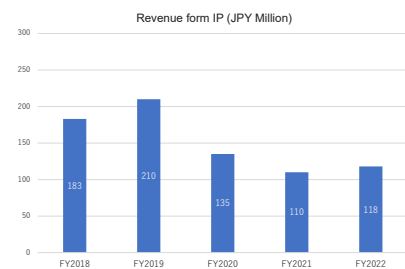

Fig.4 : Trends in revenue from intellectual property

with the previous fiscal year (Fig. 4).

To introduce NICT technology seeds transformed into intellectual property to industry, we actively presented intellectual property and technology use cases on the web and through technology briefings and introductions. As one example of an event oriented to outside parties, we co-sponsored, with the Japan Science and Technology Agency (JST), an "NICT New Technology Presentation Meeting" (held online on October 27, 2022 with 253 participants). At this event, researchers themselves introduced NICT technologies to companies interested in industry-academia collaboration and responded to individual questions. At Interop TOKYO 2023 (June 14-16, Makuhari) and CEATEC 2023 (October 17-20, Makuhari), we worked with the technology transfer recipient companies to showcase our technology transfer efforts and examples of the introduction of these technologies.

In order to contribute to the creation of Beyond 5G intellectual property, we held a patent ideathon under the leadership of the Beyond 5G Research and Development Promotion Unit. In FY2022, it was composed of members from multiple laboratories in order to combine technologies from different fields, and we introduced a staged discussion process for proceeding from ideas to technologies.

Promotion of Standardization Activities

Concerning the standardization of Beyond 5G, technologies being researched at NICT were incorporated in the Future Technology Trends Report prepared by the ITU-R

Study Group (SG) 5, Working Party (WP) 5D (completed in June 2022 and approved in November 2022). The draft new Recommendation on the IMT-2030 Framework, which summarizes the major capabilities and concepts of IMT-2030, Beyond 5G system, was agreed in WP5D in June 2023 and approved at the Radiocommunication Assembly in November 2023. In the 3rd Generation Partnership Project (3GPP), we presented proposals on key issues for Release 18, referring to technologies being researched at NICT, and collaborated with private companies in discussion about the study items for Release 19. (Fig. 5).

Regarding the metaverse, discussion on use cases and technological requirements has progressed in the ITU-T Focus Group on metaverse (FG-MV) established in December 2022. NICT has provided a vice-chair to the FG and is contributing to its discussions.

In FY2022, we submitted 168 contribution documents to international standardization organizations based on the results of R&D conducted at NICT as well as 87 contribution documents to domestic standardization organizations. Furthermore, a total of 66 members of NICT play key roles as part of management teams of standardization meetings in international fora such as the ITU-T SG13 chair, ITU-T FG-MV vice-chair, and ITU-D SG2 vice-chair. A total of 81 people were also appointed as members of domestic committees and other meetings, which hold discussions on domestic standards and Japan's policy stances for international standardization meetings. In addition, we contributed to the establishment of 24 international standards, and two domestic standards based on the R&D results of NICT.

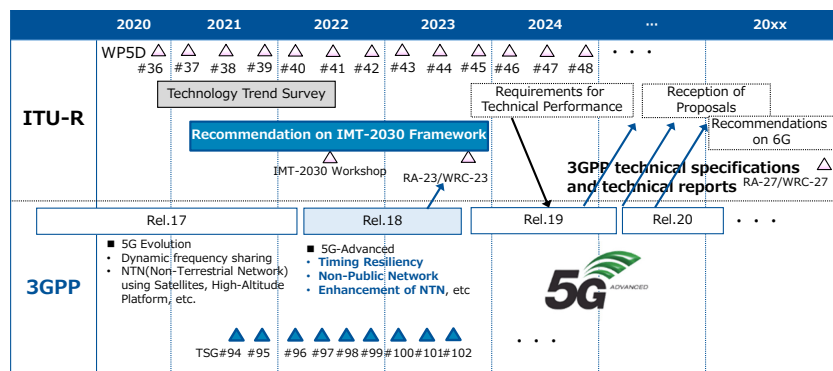

Fig.5 : Standardization-related activities of Beyond 5G

Open Innovation Global Alliance Department

Executive Director YAMAGUCHI Norifumi

Aiming for the maximization and global dissemination of R&D outcomes, the Global Alliance Department promotes international collaboration in NICT's R&D activities and the international deployment of R&D outcomes.

Building International Collaborative Relationships and Promoting New Collaboration

We have built and maintained international collaborative relationships by exchanging 12 memorandums of understanding (MOUs) (four new and eight renewed) with overseas universities and research institutes, among other partners (79 MOUs with 76 institutions in 24 countries as of the end of FY2022 (Fig. 1)), and handled a total of 13 visits by overseas government officials and university officials for the purpose of research collaboration (such as the MOU signing ceremony with the University of Oulu, Finland). Under these MOUs, we have contributed to the commencement and expansion of new international collaboration activities, including promotion of international col-

laboration in the Beyond 5G/6G area with the University of Oulu, Finland, and the Institute for Infocomm Research, Singapore; promotion of space communications experiments with the National Applied Research Laboratories (NARLabs), Taiwan; promotion of time frequency comparison joint experiments at standard time with the Korea Research Institute of Standards and Science (KRISS); and the rollout of disaster-resistant network technology with the Center for Information and Communication Technology for Development, Nepal.

Collaboration with Southeast Asia and Promotion of International Joint Research Projects

We expanded the structure of the virtual research collaboration organization ASE-

AN IVO (ICT Virtual Organization of ASEAN Institutes and NICT), which was jointly established in February 2015 with research institutes, universities, and other partners in the ASEAN region (Fig. 2). We also held the ASEAN IVO Forum 2022 in a hybrid format, with both in-person and online participation. Ideas for a total of 25 projects targeting fields such as food, environmental protection and disaster prevention and mitigation, secure and smart communities, and health and welfare, were presented by the participants, and lively discussions were held.

Promotion of International Joint Research with the United States and Europe

Under the Japan-US Network Opportunity 3 (JUNO3) international joint research program in the network area managed jointly with the US National Science Foundation (NSF), we commenced five Japan-US joint research projects (four external and one internal) in September 2022 with the theme of R&D into Programmable Networking for next generation core and Beyond 5G/6G networks. In parallel with this, under the Collaborative Research in Computational Neuroscience (CRCNS) international joint research program targeting the computational neuroscience area with the participation of the US, Germany, France, Israel, Spain, and Japan (NICT), we have newly commenced one joint research project (the role of astrocyte production in cerebral convolution formation: integrated in vivo and in silico research), and invited

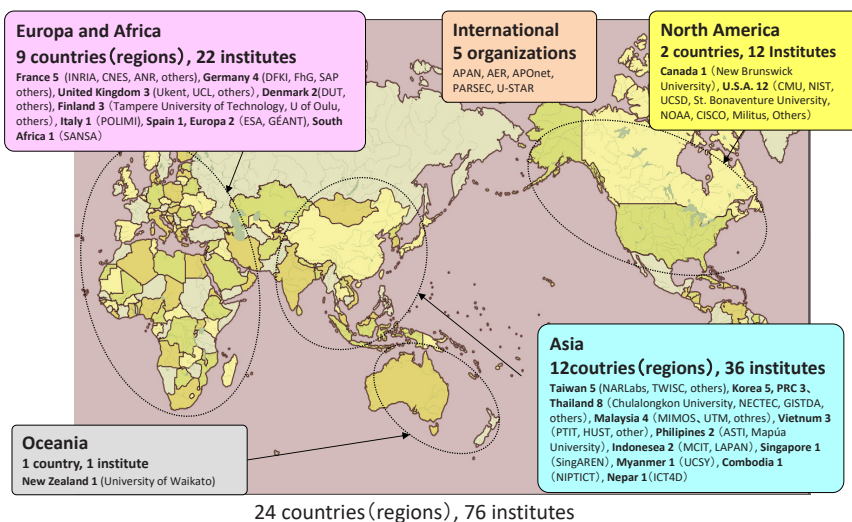

Fig. 1 : Overseas Institutes with which NICT has concluded research memorandums (end of March 2023)

applications for new joint research to commence in FY2023.

Regarding Japan-Europe international joint research conducted jointly with the European Commission and the Ministry of Internal Affairs and Communications, we implemented the finishing evaluation of one joint research project commenced in 2018 (TeraHertz end-to-end wireless systems supporting ultra high data rate applications) online (Fig. 3). Furthermore, together with the Ministry of Internal Affairs and Communications, we reviewed how to proceed going forward.

Operations Related to Security Export Controls

In order to comply with the “compliance standards for exporters and persons conducting similar transactions” stipulated in the Foreign Exchange and Foreign Trade Act (FEFTA), NICT carried out the procedures for determining applicability and screening transactions pertaining to security export controls based on the Security Export Control Regulations, and acquired an export license from the Minister of Economy, Trade and Industry when necessary. In particular, in FY2022, in order to comply with the review of the deemed exports system arising from the revision of the FEFTA Ministerial Ordinance and Circular Notice and the export regulations of foreign countries such as the United States’ Export Administration Regulations (EAR), we reviewed the Security Export Control Regulations and wrote and distributed the Security Export Controls Handbook (August 2022, third edition) to foster the understanding of the NICT staff concerning the latest systems and regulations. Furthermore, we carried out educational activities through briefings and e-learning, etc., to foster a deeper understanding of security export controls among our staff and to ensure that the export controls of NICT would be implemented steadily.

Participating in International Exhibitions, etc.

For the international rollout of the R&D outcomes of NICT, we actively participated in a range of events and international exhi-

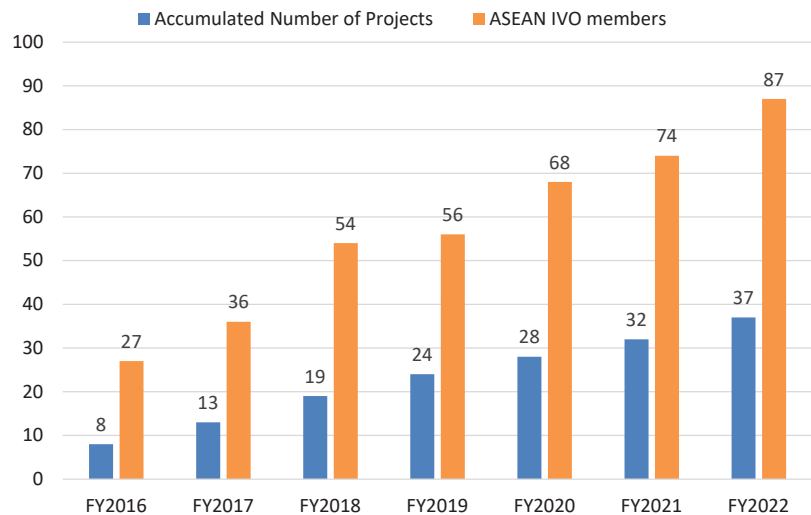

Fig.2 : Number of ASEAN IVO-affiliated projects and institutions (cumulative total, the horizontal axis is the fiscal year)

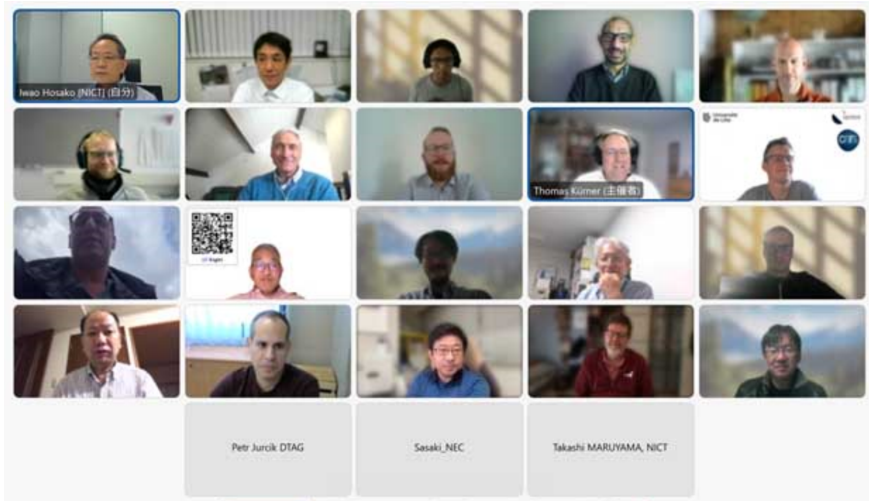

Fig.3 : Japan-Europe International Joint Research Project (TeraHertz end-to-end wireless systems supporting ultra high data rate applications) Online Final Review (September 2022)

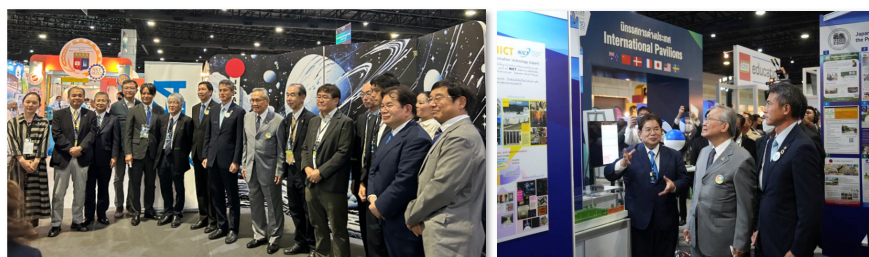

Fig.4 : Exhibits at the National Science and Technology Fair 2023, hosted by the Government of Thailand (August 2023, Thailand) (Left: Mr. Don Pramudwinai, Deputy Prime Minister and Minister of Foreign Affairs of Thailand (middle) and people involved in the Japanese booth, right: explanation to Deputy Prime Minister and Minister of Foreign Affairs Don concerning the content of the exhibit by NICT)

bitions, etc. For example, we organized technical exhibits and introduced technologies at the National Science and Technology Fair 2023, which was hosted by the Government of Thailand (August 2023,

Thailand; Fig. 4), and the Open Compute Project Global Summit 2023 (de facto standard organization for data centers, October 2022, USA).

Open Innovation

ICT Deployment and Industry Promotion Department

Executive Director HOMMA Yuichi

The ICT Deployment and Industry Promotion Department is supporting the creation and development of regional ICT startups, enhancing and improving information and communications infrastructure, promoting a barrier-free information environment, encouraging fundamental technology research in the private sector, and supporting international exchanges in R&D, among other measures, from the perspective of utilizing information and communications technology, which is the foundation of social life and economic activities, to support the revitalization of industries, the realization of an inclusive society in which everyone can lead a safe, secure, and prosperous life, and the widespread use of information and communications services in the lives of the citizens.

Support for the Creation and Development of Regional ICT Startups

From the policy perspective of strengthening Japan's medium-to-long-term industrial competitiveness in the information and communications field, we are implementing the NICT Accelerator Program as support for the discovery and development of ICT startups.

The "Entrepreneurs' Koshien" and the "Entrepreneurs' Expo"

The "Entrepreneurs' Koshien" was held on March 7, and the "Entrepreneurs' Expo" was held on March 8, 2023, both at the Marunouchi Building Hall and Conference Square (Chiyoda City, Tokyo). Both events were held fully in-person in a real venue for the first time in four years.

From the nine teams that participated in the "Entrepreneurs' Koshien," Human Site/Hokkaido University Graduate School (Representative: Naoya Yamaishi) won the Minister of Internal Affairs and Communications Award for "TIBr radiation sensor aimed at applications in medical diagnosis equipment" and Avatar Video Studio/Kobe University (Representative: Masanori Kato) won the Special Jury Award for the "Project to provide a platform which automatically generates avatars with one click" (Fig. 1).

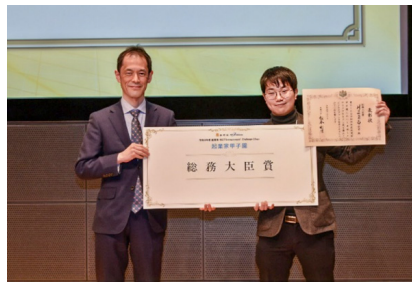

Fig.1 : "Entrepreneurs' Koshien" Awards Ceremony



Fig.2 : "Entrepreneurs' Expo" Awards Ceremony

At the "Entrepreneurs' Expo," from the eight participating companies, yuni, Inc. (CEO: Kenshi Uchihashi) won the Minister of Internal Affairs and Communications Award for "Collecting bedding and converting it into recycled materials in order to turn incinerating disposal sites into recycling plants and transform Japan from a major waste-producing country to a resources-rich country" and iTips Inc. (CEO: Ratnesh Kumar) won the Special Jury Prize

for "Oyakata Web3 era workman career-building system for eliminating the shortage of human resources in the construction industry" (Fig. 2).

Creating Information and Exchange Opportunities for ICT Startups

We are utilizing not only in-person forums but also online media to provide op-

portunities for information and exchanges useful for the launch of ICT startups, thereby encouraging the commercialization of the promising, novel, and spreadable technologies and services they possess.

Promotion of Barrier-Free Information Environment

We contribute to the balanced development of informatization in Japan with the aim of realizing a barrier-free information environment in which everyone can use communications and broadcasting services equally.

We produce programs with subtitles, sign language, and explanations to help people with visual and hearing disabilities view television broadcasting, produce broadcast programs with composite display of sign language translation videos, and subsidize a part of the expenses for putting in place equipment for subtitling live-broadcast programs.

We subsidize a portion of the funding for projects that provide and develop services to enable persons with disabilities to use communications and broadcasting services smoothly.

We provided useful information for persons with disabilities, the elderly, and related business operators, as well as information on the overview and results of NICT's barrier-free information accessibility project (subsidy system) through the "Portal site for barrier-free access to information" (Fig. 3) on the NICT website. Furthermore, we operated the Information Accessibility Support Navigator (Act-navi) database, which was built by the Ministry of Internal Affairs and Communications, to provide needs information, seeds information, and expert information, etc., pertaining to the use of information and communications by persons with disabilities.

NICT exhibited at the 50th International Home Care and Rehabilitation Exhibition (Tokyo Big Sight, September 27-29, 2023), presented the results of its barrier-free information accessibility subsidy project, introduced "KoeTra," an example of the technology transfer of NICT's research outcomes, and publicized information on NICT's initiatives related to barrier-free access to information.

Inviting Overseas Researchers and Providing Support for the Hosting of International Research Conferences

We accept overseas researchers into research institutions such as universities in Japan through the NICT International Ex-

change Program Foreign Researcher Invitation Program and Japan Trust International Research Cooperation Program. We also support the holding of international research conferences under the International Exchange Program by assisting with the hosting of international research conferences in Japan.



Fig.3 : Portal site for barrier-free access to information by NICT(At present, only available in Japanese)

Table 1 : Track record of support for inviting overseas researchers and hosting international research conferences (unit: number of programs) (excluding those continued from the previous fiscal year)

Category	FY2018	FY2019	FY2020	FY2021	FY2022
International Exchange Program (invitation) (including Japan Trust)	12	7	2	2	12
International Exchange Program (conferences)	10	10	10	8	11

(Note) The Japan Trust International Research Cooperation Program is operated as a joint effort of NICT together with the New Energy and Industrial Technology Development Organization (NEDO). NICT invites researchers in the fields of communication and broadcasting infrastructure technology, and NEDO invites researchers in fields related to fundamental technology for the mining and manufacturing industries.



Research Highlights

Researchers

Research Highlights

- 40 Successful Japan-Europe joint experiment on integration of satellite links in Japan-Europe long distance 5G network
- 41 International reference computational models for children released free of charge
- 42 World's first demonstration of Terahertz signal transparent relay and switching
- 44 Rocket equipped with JUper ICy moons Explorer (JUICE) successfully launched!
- 45 Successful development of a differential absorption Lidar that captures the flow of water vapor
- 47 The holes in the ionosphere caused by the eruption of a submarine volcano off the coast of Tonga
- 49 Successful demonstration of optical wireless communications in sunlight using Deep-Ultraviolet LED in Non-Line-Of-Sight configurations
- 51 Development of a cross-organizational analysis function of the integrated cyber attack analysis platform "NIRVANA Kai"
- 52 Building prototype Japanese language specific Large Language Models (LLM, Generative AI)
- 54 Establishment of accurate permittivity measurement technology using the Millimeter wave/Terahertz band

Researchers

- 56 Person 1 Pham Tien Dat
- 57 Person 2 JIN Hidekatsu
- 58 Person 3 IWAKI Mitsuhiro

Innovative Network Area

Successful Japan-Europe joint experiment on integration of satellite links in Japan-Europe long distance 5G network

Contributing to the realization of a seamlessly connected space and terrestrial networks

NICT, the Japan Radio Co. Ltd, the Sky Perfect JSAT Corporation, and the University of Tokyo, School of Engineering, Nakao Research Laboratory jointly worked to conduct a Japan-Europe joint experiment for connecting satellites and 5G, including a Japan-Europe long-distance network. Successful transmission of a 5G control-plane signal, 4K video, and IoT data was achieved in January and February of 2022 for the first time in Japan. This experiment was conducted in collaboration with the European Space Agency (ESA), Eurescom GmbH, and Fraunhofer

FOKUS Institute. This joint experiment shows that 5G communications can be established over long-distance links between Japan and Europe, including satellite links, and be expected to lead to the early spread of 5G networks in places where 5G deployment has been difficult, such as in the sky, at sea, or on remote islands.

A part of this research's results was obtained from the commissioned research "Research and Development of Satellite-Terrestrial Integration Technology in Beyond 5G" (No. 21901) by NICT, JAPAN.

In 5G/Beyond 5G, "non-terrestrial networks (NTN)" are attracting attention from the perspective of scalability and a wide range of communication. The NTN is a system that connects different spaces, such as the sea, sky, and space, without barriers via various platforms, such as satellites, high-altitude platform stations (HAPS), and drones. In addition, by connecting NTN and 5G/Beyond 5G terrestrial systems, users will be able to communicate wherever they are. The Third Generation Partnership Project (3GPP) is studying the standardization for the interconnection of NTN and 5G,

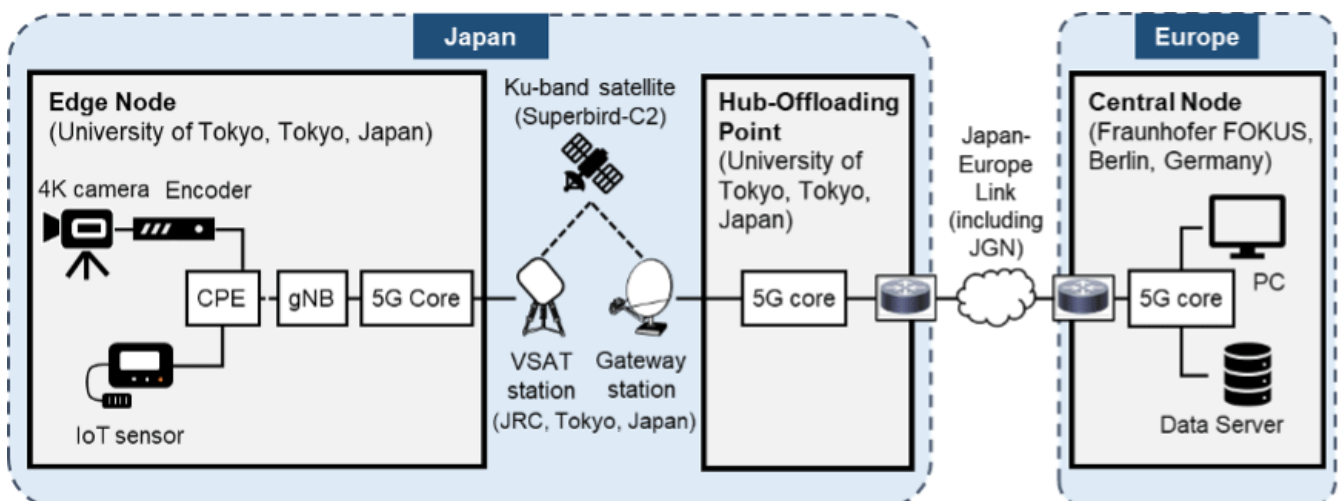

Fig.1 : System configuration of the testbed in the Japan-Europe joint experiment.

which is expected to improve performance in conventional use cases and realize new use cases.

With this background, NICT and the ESA signed and renewed the Letter of Intent (LoI) in 2018 and 2020, and have been planning a Japan-Europe joint experiment for the purpose of connecting satellites and 5G over a long-distance network in order to contribute to the realization of 5G/Beyond 5G including international long-distance communications such as global mobility of aircraft and international roaming. Through the experiment, we have gained a lot of knowledge about 5G connections through communication lines with different characteristics of ground and satellite systems for the realization of

Beyond 5G with a seamless connection between the ground and space.

We built a testbed for the Japan-Europe joint experiment connecting the Ku-band satellite (12GHz/14GHz band frequency), local 5G systems, and JGN operated by NICT between Japan and Europe. Fig. 1. shows the configuration of the constructed testbed.

We successfully transmitted both 4K video and IoT data using the testbed. In this experiment, we verified that even under the influence of latencies caused by long-distance transmission, including satellite and Japan-Europe terrestrial links, it was possible to establish a communication session using 5G control signals exchanged between the customer-premises equipment (CPE, 5G

gateway) in Japan and the 5G core in Europe; subsequently, the data acquired by the 4K camera and IoT sensor in Japan were transmitted to a PC and data server in Europe. Furthermore, we measured the network quality of each transmission segment and evaluated the network performance by connecting satellite links and 5G.

Reference

ESA, Telecommunications and Integrated Applications Directorate (TIA): Space-enabled 5G links forged for the first time between Japan and Europe

URL: https://www.esa.int/Applications/Telecommunications_Integrated_Applications/Space-enabled_5G_links_Japan_and_Europe

Advanced Electromagnetic Technology Area

International reference computational models for children released free of charge

Available for computational simulations such as electromagnetic absorption in children

NICT has developed computational human body models for children aged 1, 5, and 10 years whose body shape and anatomical structure match international references. These models are available free of charge for non-commercial use and are useful for diverse simulations, such as studying electromagnetic field (EMF) dosimetry and human body injuries in car accidents and enhancing diagnostic and therapeutic practices.

NICT has developed international reference computational human models of children to enable highly generalizable EMF dosimetry unaffected by individual differences. These child models are now available free of charge for non-commercial research purposes. Their terms and conditions of use can be found on the following page:

https://emc.nict.go.jp/bio/data/index_e.html.

The released models represent 1-, 5-,

and 10-year-old children using fine blocks (2 mm cubes) to represent their anatomical structures (Fig. 1). Each block corresponds to about 50 different tissues or organs, adjusted to match the International Commission on Radiological Protection (ICRP)'s reference values for body shape and tissue and organ masses in children. With specific electrical constants assigned to the tissues and organs in each model, the absorption of radio waves in children can be calculated.

"Japanese adult male and female models, which are already provided free of charge, have been used for various research such as medical applications development of healthcare devices, and human body damage analysis. In addition

to EMF dosimetry, and more than 300 domestic and foreign researchers have used them so far. I believe that these child models can similarly contribute to the development of various research fields," said Dr. NAGAOKA Tomoaki,

Research Manager, Electromagnetic Compatibility Laboratory, Electromagnetic Standards Research Center, Radio Research Institute.

These models offer versatility by allowing the substitution of physical properties and enabling numerical simulations and technology development in various fields. To date, adult male and female models have been useful in areas of human body damage analysis. Similarly, these child models have potential applications in various fields.

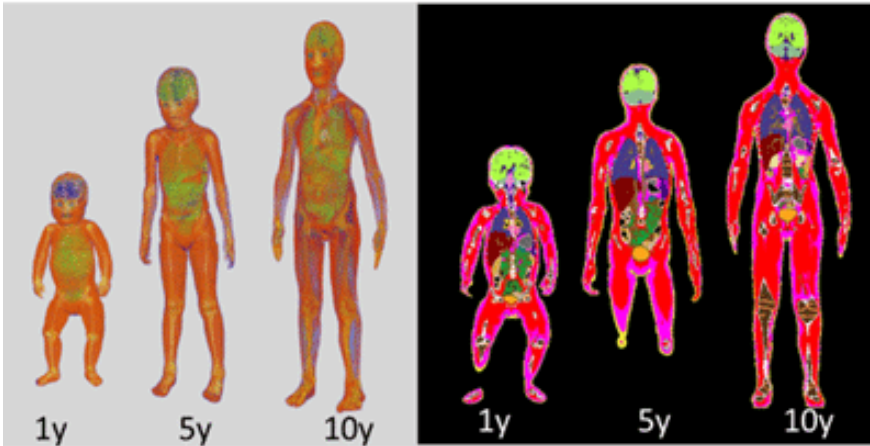

Fig.1 : International reference computational models for children (The left figure is a volume rendering display, and the right figure is a cross-sectional view).

Reference

Tomoaki Nagaoka, Soichi Watanabe, "Development of Voxel Models Adjusted to ICRP Reference Children and Their Whole-Body Averaged SARs for Whole-Body Exposure to Electromagnetic Fields From 10 MHz to 6 GHz," IEEE Access
 DOI: 10.1109/ACCESS.2019.2940736
 URL: <https://ieeexplore.ieee.org/document/8834784>

Innovative Network Area

World's first demonstration of Terahertz signal transparent relay and switching

NICT, in collaboration with Sumitomo Osaka Cement Co., Ltd., Nagoya Institute of Technology, and Waseda University, successfully developed the world's first system for the transparent relay, routing, and switching of high-speed terahertz-wave signals to different locations. Direct conversion of a 32-Gb/s tera-

hertz-wave signal in the 285-GHz band to an optical fiber and its transparent relay and switching to different access points in ultrashort time periods were successfully demonstrated.

The key technologies include a newly developed low-loss optical modulator for the direct conversion of terahertz-wave signals to optical signals and an

adaptive fiber-wireless technology for the ultrafast switching of terahertz signals. The developed system overcomes the disadvantages of radio communications in the terahertz band, such as high free-space loss, weak penetration, and limited communication coverage, paving the way for the deployment of terahertz communications in beyond 5G

and 6G networks.

The results of this demonstration were published as a postdeadline paper at the 2023 International Conference on Optical Fiber Communications (OFC 2023) and were presented on Thursday, March 9, 2023 (local time).

In this study, the research team demonstrated the first system for the transparent relay, routing, and switching of terahertz signals in the 285-GHz band (Fig.1) utilizing two key technologies: (i) a newly developed low-loss optical modulator and (ii) an adaptive fiber-wireless technology using an ultrafast wavelength-tunable laser. In the system, terahertz signals are received and directly converted into optical signals using terahertz-optical conversion devices with low-loss optical modulators. Lightwave signals from tunable lasers are input to the modulators, and wavelength routers are used to route the signals to different access points where specific wavelengths are assigned. At the access points, the modulated optical signals are converted back into tera-

hertz signals using optical-terahertz converters. Terahertz signals can be switched to different access points by switching the wavelengths of the tunable lasers. The tunable lasers can be independently controlled, and the number of access points that can simultaneously generate terahertz signals equals the number of active tunable lasers.

Dr. Pham Tien Dat, Senior Researcher (more on page 56) said, "Radio frequencies in the terahertz band are promising candidates for ultra-high data-rate communications in 6G and beyond networks. Terahertz signal processing, such as transparent relay, routing, and switching, is crucial in facilitating the deployment of this technology. However, these functions cannot be realized using electronic technologies. In this regard, photonic technology and convergence with its radio counterpart are promising to realize new communication features and applications. The success of this demonstration reveals the potential of the proposed system and can pave the way for further research

and development in the field."

"We would like to continue developing various devices and systems in this field for the future access network," said Dr. Kouichi Akahane, Director of Optical Access Technology Laboratory.

In the future, we will study the terahertz-optical conversion device and fiber-wireless technology developed in this study to further increase the radio frequency and transmission capacity. In addition, we will promote international standardization and social implementation activities related to fiber-wireless and terahertz-wave communication systems.

Reference

Pham Tien Dat, Yuya Yamaguchi, Keizo Inagaki, Shingo Takano, Shotaro Hirata, Junichiro Ichikawa, Ryo Shimizu, Isao Morohashi, Yuki Yoshida, Atsushi Kanno, Naokatsu Yamamoto, Tetsuya Kawanishi, Kouichi Akahane, "Transparent Relay and Switching of THz-wave Signals in 285-GHz Band Using Photonic Technology," International Conference: 2023 Optical Fiber Communications (OFC 2023), March 2023, paper Th4A.6 (PostDeadline Paper)

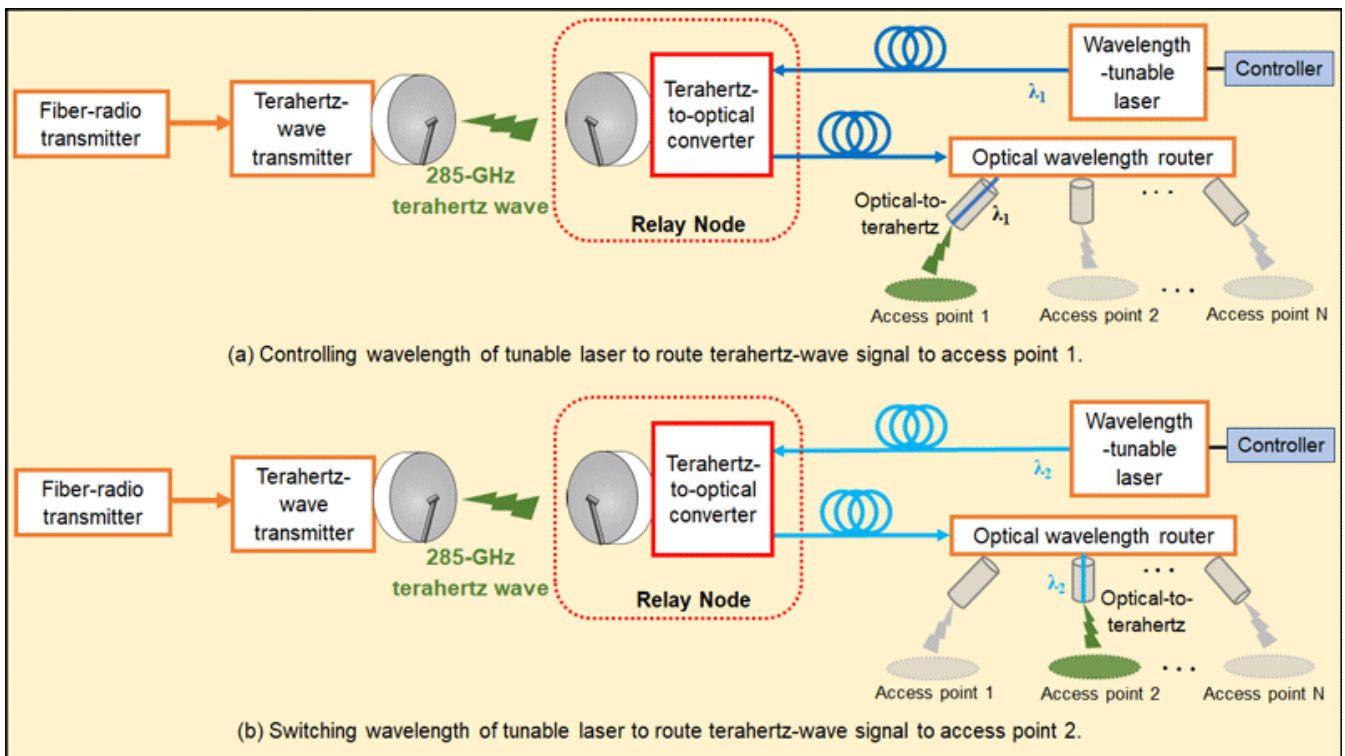

Fig.1 : Concept of transparent relay and switching of terahertz-wave signals using direct terahertz-optical conversion and optical wavelength control

B5G Field

Rocket equipped with JUpiter ICy moons Explorer (JUICE) successfully launched!

Using Terahertz to explore habitability for life

On April 14, 2023 (Friday), the JUpiter ICy moons Explorer (JUICE), a large-scale European Space Agency (ESA) mission, was launched successfully.*1 One of the 11 scientific instruments on board JUICE is the Submillimeter Wave Instrument (SWI), a terahertz wave spectrometer. SWI was developed by an international team including NICT, with NICT working on the primary and secondary mirrors, and the actuator (Fig. 1). We are also conducting research into unique algorithms capable of extracting key information from observational data about the possibility of the existence of life.

The Ariane 5 rocket equipped with JUICE will next perform a flyby of Earth and Venus and is planned to arrive in the Jovian system in 2031.

JUICE is a mission to comprehensively explore the appearance of Jupiter, as a typical gas giant planet in space, and also search for the possibility of life existing in the subterranean seas of Jupiter's icy moons. This mission is to be implemented by observing the gas giant Jupiter and orbiting icy moons such as Ganymede, Europa, and Callisto. It is thought that the surfaces of Ganymede and Europa are mostly covered in ice, but that below this icy crust lie vast sub-

terranean seas. Understanding the composition of these seas, such as whether they are oxidative or contain reductive substances, is important for discussing the possibility of the existence of life. In particular, on Europa, there are already known to be plumes where water and other substances from the subterranean seas or icy crust erupt from the surface into space, and it may be possible to estimate sea composition from observations of Europa's atmospheric composition. With terahertz wave observation using SWI, it is anticipated that in addition to atmospheric water, oxygen, carbon monoxide and its isotopes, exploration for other key molecular species will be possible, including H_2S , CH_4 , NH_3 , C_3H_2 , CH_3OH , and H_2CO .

In order to accurately estimate atmospheric information, a terahertz radiative transfer model capable of properly expressing new physical processes needs to be developed. In particular, Jupiter's icy moons have extremely thin atmospheres, so quantification of such molecular abundance requires the development of a non-local thermodynamic equilibrium (Non-LTE) model, in order to determine the molecules' equilibrium state of level distribution, which is different from that on Earth. To understand these physical processes, NICT is independently developing a terahertz radiative transfer model incorporating a non-LTE model*2 (Fig. 2), which, compared to other models around the world,

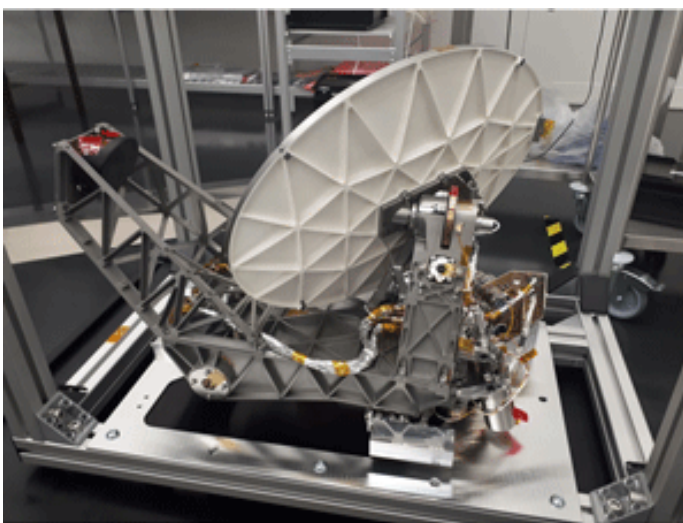

Fig. 1 : SWI antenna and receiver unit
NICT worked on the primary and secondary mirrors, and the actuator
<https://www.mps.mpg.de/planetary-science/juice-swi>
© MPS

has been confirmed as being the most accurate and standardized model available. We anticipate that observation data collected by JUICE/SWI will be used to characterize the Jovian system through dynamic studies of the interactions between gas giant Jupiter and its icy moons.

Planetary exploration through terahertz waves is a field that has only just begun. It holds great promise for the future, and we will continue challenging ourselves to bring dreams and discoveries to many people.

Reference

- *1: NICT press release (Japanese) <https://www.nict.go.jp/press/2023/04/17-1.html>.
- *2: T. Yamada et al., Solving non-LTE problems in rotational transitions using the Gauss-Seidel method and its implementation in the Atmospheric Radiative Transfer Simulator, *Astronomy and Astrophysics*, 2018.

Radiative Transfer model for icy-moons

Non-LTE physical process

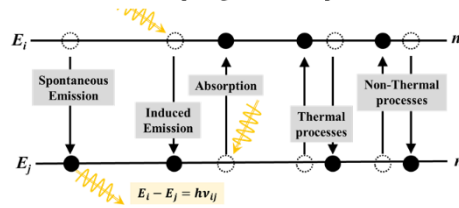

Observation simulation for Ganymede atmosphere (water molecules)

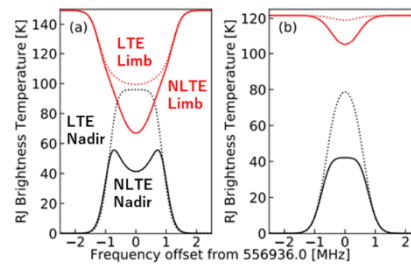

Fig.2 : NICT development of unique algorithm

Advanced Electromagnetic Technology Area

Successful development of a differential absorption Lidar that captures the flow of water vapor

Enabling simultaneous observation of water vapor and wind, and more accurate forecasting of rainstorm locations

NICT's Radio Research Institute has developed a "differential absorption lidar (DIAL)" that can simultaneously observe water

vapor(H₂O), and wind in the atmosphere in all directions at both day and night. The DIAL, developed using NICT's proprietary laser light wavelength locking

technique, has demonstrated a technique for observing the amount of water vapor with an error of less than 10%. According to NICT, assimilating the ob-

served data of water vapor and wind into numerical weather prediction models will greatly improve the accuracy of forecasting the locations of quasi-stationary band-shaped precipitation systems (Senjo-Kousuitai) that experience heavy rainfall.

The results were published in the US scientific journal *Optics Express* on April 24 (Monday), 2023 (US Eastern time).

Aiming to prevent and mitigate disasters resulting from weather phenomena that bring heavy rainfall, including guerrilla heavy rainfall and Senjo-Kousuitai, NICT is advancing R&D into technologies for observing rain, including multi-parameter phased array weather radar. Information on atmospheric water vapor and winds prior to the onset of heavy rainfall is important for improving the accuracy of forecasting the weather phenomena that bring heavy rainfall. A variety of instrument has been developed for observing each, but they have various issues. For example, instrument using laser light that is not safe for the eyes could be used to observe water vapor, but only in the vertical direction,

and observations in the daytime were affected by background sunlight. There was therefore no instrument capable of simultaneous observations of water vapor and wind in all directions both day and night.

The H₂O DIAL, developed by NICT uses infrared laser light with a wavelength of 2 μm, which is relatively safe for the human eyes, and can be emitted in any direction. The wavelength range of 2 μm is less affected by solar background light than the other wavelength ranges used for lidars. Furthermore, the effect of solar background light is greatly suppressed by using a system that receives a narrow bandwidth of light. These technologies have enabled daytime and nighttime observations of water vapor and wind in the atmosphere.

Moreover, by incorporating NICT's proprietary laser light wavelength locking technique in this H₂O DIAL, we showed, during actual observations in summer, when water vapor content is high, that the results demonstrated good agreement with those from radiosondes and that measurement error of

10% or less could be achieved, which is required for data assimilation into weather prediction models. Furthermore, we carried out horizontal observations of the water vapor and wind near the surface, and obtained results that showed good agreement with those from surface meteorological sensors (Fig. 1).

NICT will continue to develop high-power pulse lasers for high-precision and -frequency, and long-range observations of water vapor and wind. We will also verify the accuracy of the H₂O DIAL, using the developed pulse lasers to improve the accuracy of weather forecasts. Furthermore, we are developing an inexpensive system with the aim of spreading this H₂O DIAL, in society.

Reference

Hironori Iwai and Makoto Aoki, "Evaluation of a coherent 2-μm differential absorption lidar for water vapor and radial wind velocity measurements," *Optics Express*, vol. 31, Issue 9, pp. 13817-13836, 2023.
DOI: 10.1364/OE.485608
<https://doi.org/10.1364/OE.485608>

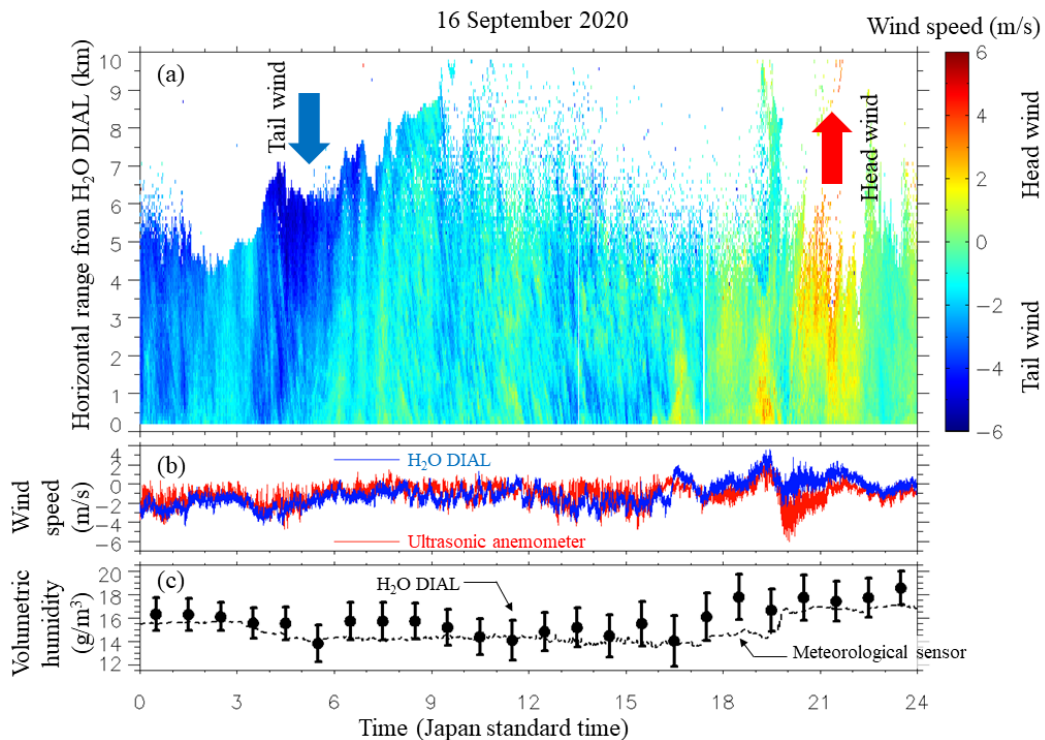

Fig. 1 : (a) Range-time display of quasi-horizontal radial velocity for off-line wavelength observed using the H₂O-DIAL system on 16 September 2020. Positive (negative) velocities, represented in red and yellow (blue), indicate flow away from (toward) H₂O-DIAL. (b) Time series of 1-s-averaged radial velocities from H₂O-DIAL (blue) and ultrasonic anemometer (red). (c) Time series of the volumetric humidity measured using the H₂O-DIAL system and meteorological sensor on 16 September 2020. Circles show the means and vertical lines show the random error of the volumetric humidity measured using the H₂O-DIAL system.

Advanced Electromagnetic Technology Area

The holes in the ionosphere caused by the eruption of a submarine volcano off the coast of Tonga

The connection between the geosphere and the space sphere as seen from cutting-edge observations

A research group comprised of researchers from the NICT Space Environment Laboratory and the Institute for Space–Earth Environmental Research, Nagoya University, etc., analyzed the data of the Global Navigation Satellite System (GNSS), the meteorological satellite Himawari, "Arase" satellite for the exploration of energization and radiation in geospace (ERG), and Ionosonde and successfully observed the irregular structure of the ionospheric electron density caused by the concentric air pressure waves accompanying the large-scale eruption of a submarine volcano off the coast of Tonga in the South Pacific Ocean.

In the observation data, a large number of holes in the ionosphere, where electron density rapidly depletes, were observed over Japan at one to two orders of magnitude more than usual, and through the observations of the Arase (ERG) satellite, we learned that these holes in the ionosphere stretch 2,000 km into outer space. Furthermore, we learned that the formation of the holes in the ionosphere was caused by the upward motion of the ionosphere and that the upward motion occurred approximately one to two hours before the arrival of the air pressure waves caused by the volcanic eruption. The holes in

the ionosphere cause radio disturbance, so they are an item for which forecasting is necessary from the perspective of space weather. It is widely known that space weather phenomena which cause radio disturbance are caused by solar activity such as solar flares, etc., but these research results are an important case clearly showing that the radio disturbance can also be caused by phenomena on the surface of the earth such as large-scale eruptions, etc. This research outcome was presented on May 22, 2023, at 6 PM (Japan time) in the general international academic journal *Scientific Reports*, which is published by Nature Research.

Some of the molecules and atoms present in upper atmosphere surrounding the earth (altitude: at least 100 km) are ionized by ultraviolet rays and X-rays which come from the sun, forming the ionosphere. The radio waves used in the GPS and other Global Navigation Satellite Systems (GNSSs) and in the satellite broadcasting and communication essential to our modern lives inevitably pass through this area. Once a disturbance in the ionosphere occurs due to solar activity such as solar flares, etc., meteorological phenomena such as typhoons, and geologic phenomena such as earthquakes and volcanic eruptions,

a positioning error may occur in GPS measurement. Conversely, by paying attention to this error information, we can obtain information about the ionosphere, so research into global ionosphere disturbance using GNSS receiver network data has progressed. Currently, GNSS receiver network data is being used in applied research into space weather forecasting, etc.

In the Equatorial region, the earth's magnetic field is horizontal with respect to the ionosphere, so several phenomena unique to the equatorial ionosphere occur. One of those is the phenomenon called a plasma bubble which is a "hole in the ionosphere" with an electron density at least two orders of magnitude lower than the surrounding area and an interior filled with a spatially disordered electron density structure (irregular structure of the electron density). The irregular structure of the ionospheric electron density accompanying this plasma bubble has a negative impact on satellite positioning and communication, etc. Therefore, predicting and forecasting under what kinds of conditions a plasma bubble will occur is seen as important within space weather research. Nonetheless, we did not sufficiently understand what kinds of conditions plasma bubbles occur under or

how the variations in the lower atmosphere are involved in the occurrence of plasma bubbles.

On January 15, 2022, a large-scale submarine volcanic eruption, which was described as a once-in-a-thousand-year event, occurred off the coast of Tonga in the South Pacific Ocean, causing intense air pressure waves and high-speed tsunamis all around the world, and the fact that a plasma bubble was occurring over the Asian region was picked up by ground-based ionospheric observations. Currently, many scientists are investigating the impact of the eruption, but we did not know how high the plasma bubble generated by this eruption reached. This research was com-

menced with the objective of carrying out analyses combining data from the Arase (ERG) satellite, which thoroughly observes a wide area from the ionospheric altitude of 400 km to outer space at 32,000 km, and from ground-based observations, to elucidate the mechanism causing the plasma bubble observed after the Tonga volcanic eruption.

These research results are significant not only from a scientific perspective but also in terms of space weather and disaster prevention. We showed from the observations that in the case of a large-scale event like the Tonga volcanic eruption, plasma bubbles can be formed even under conditions (in sea-

sons and places) which they would not normally occur. These kinds of cases have not been incorporated in space weather forecasting models, so it is expected that similar cases will be analyzed going forward and the findings obtained from those analyses will be incorporated in the models.

Reference

Atsuki Shinbori, Takuya Sori, Yuichi Otsuka, Michi Nishioka, Septi. Perwitasari, Takuo Tsuda, Atsushi Kumamoto, Fuminori Tsuchiya, Shoya Matsuda, Yoshiya Kasahara, Ayako Matsuoka, Satoko Nakamura, Yoshizumi Miyoshi, Iku Shinohara, "Generation of equatorial plasma bubble after the 2022 Tonga volcanic eruption," Scientific Reports, vol.13, article no.6450,2023 DOI: 10.1038/s41598-023-33603-3

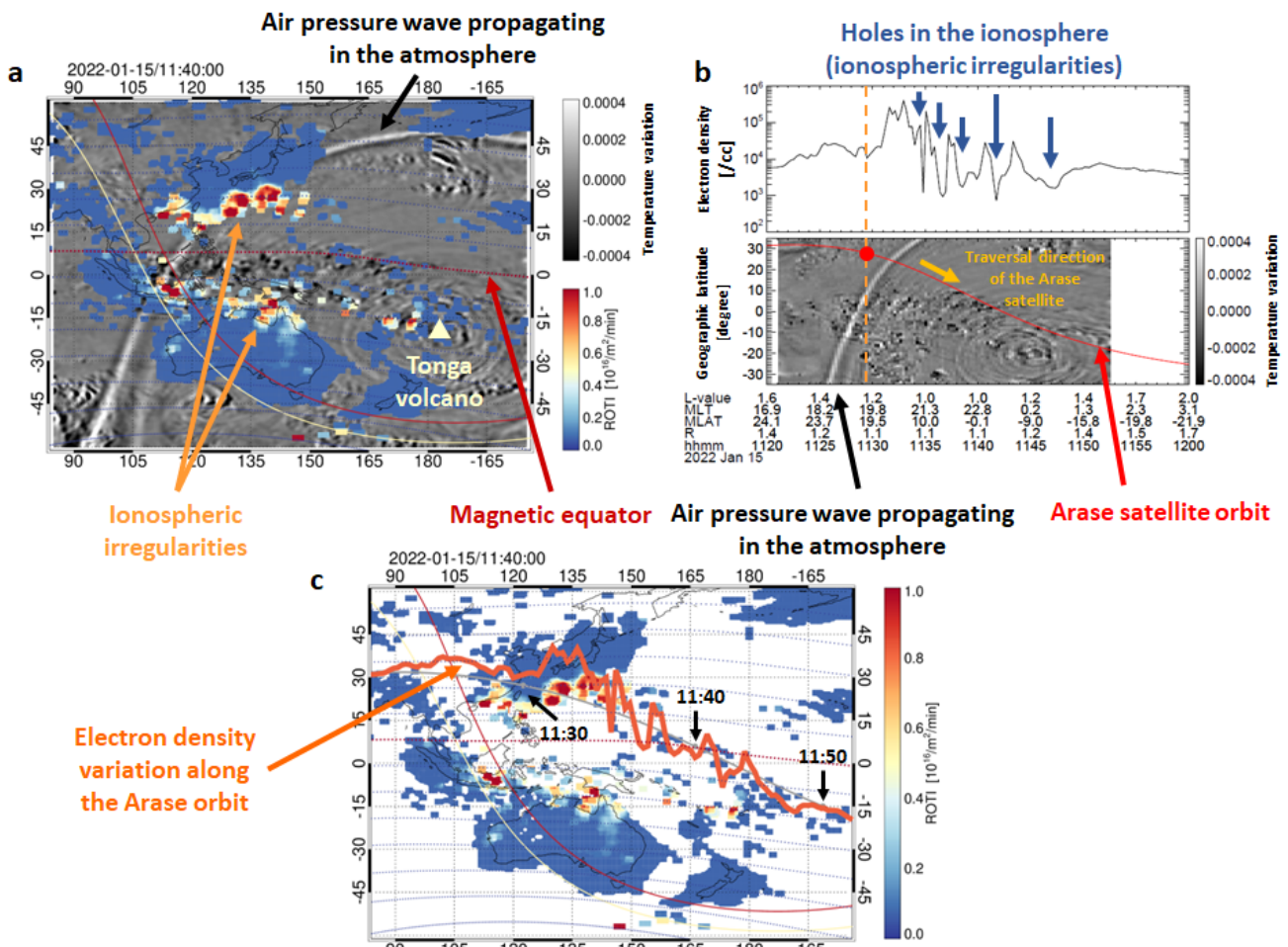

Fig. 1 : Observed irregular structure of the ionospheric electron density caused by the concentric air pressure after Tonga volcano eruption

Frontier Science Area

Successful demonstration of optical wireless communication in sunlight utilizing Deep-Ultraviolet LED in Non-Line-Of-Sight configurations

Realization of innovative optical wireless communication which is not obstructed by obstacles such as office buildings, etc., or sunlight background noise

The research group led by Director Shin-ichiro Inoue of the NICT Advanced ICT Research Institute utilized deep-ultraviolet (DUV) light-emitting diodes (LEDs) to demonstrate optical wireless communication transmission during the day and outdoors, when there is a lot of background noise caused by sunlight, and in a non-line-of-sight (NLOS) environment with obstacles such as office buildings, etc., between the transmitter and receiver. It became the first in the world to succeed at optical wireless communication transmission over 1 Mbps at a maximum distance of 80 m during the day, outdoors and in a non-line-of-sight environment, by developing a transmitter equipped with high-power single-chip deep-ultraviolet LEDs with a emission wavelength in the 265 nm band and optical output of over 500 mW, and a deep-ultraviolet light receiver capable of eliminating the sunlight background noise with high efficiency.

Note that these results were presented in the IEEE Photonics Journal (electronic version: May 31, 2023 (Wednesday) United States Eastern Time, final version).

Optical wireless communication, which uses light as the transmission medium, is resistant to electromagnetic noise and capable of high-speed and broadband data communication, and is therefore expected to be a candidate for the next-generation ultra-high-speed wireless communication system. On the other hand, one difficulty when using light as a transmission medium in a free space is that light, which has a shorter wavelength than radio waves, has a higher straightness than radio waves so it cannot pass through solid objects such as buildings, etc. For this reason, optical wireless communication has been limited to use in communication in a line-of-sight (LOS) environment in which there are no obstacles blocking the light on the way and the transmitter and the receiver face each other with a clear line of sight. Furthermore, in conventional optical wireless communication using visible light and infrared light, there was the problem that it was extremely strongly affected by background noise caused by sunlight. Therefore, optical wireless communication during the day, outdoors and in a non-line-of-sight environment has generally been consid-

ered difficult until now.

In order to solve these kinds of issues, the research group has advanced research to develop aluminum gallium nitride (AlGaIn) light-emitting diodes (LEDs) which emit light in the deep-ultraviolet wavelength band (200 nm to 300 nm) and to utilize those deep-ultraviolet LEDs in optical wireless communication in a non-line-of-sight environment.

Deep-ultraviolet light with a wavelength of 280 nm or less has the property that it is strongly absorbed in the ozone layer. Due to this property, it is possible for optical wireless communication using deep-ultraviolet light of 280 nm or less to avoid the impact of sunlight background noise. Furthermore, deep-ultraviolet light, which has an extremely short wavelength compared to visible light and infrared light, has the property that it interacts strongly with the aerosols and molecules in the air and is scattered with a high probability, so even in a non-line-of-sight environment with obstacles such as office buildings, etc., between the transmitter and receiver, there is a possibility that communication can be realized by go-

ing around the obstacles via the scattering process. However, deep-ultraviolet light via this scattering process has an extremely large attenuation rate with respect to the transmission distance and the signal light becomes extremely weak in its intensity by the time it reaches the receiving side.

This time, in order to realize optical wireless communication, the team developed a transmitter equipped with the high-power single-chip deep-ultraviolet LEDs it developed itself with a emission wavelength in the 265 nm band and optical output of over 500 mW. Furthermore, it developed a receiver equipped with a double cold mirror that can eliminate sunlight background noise with high efficiency and selectively acquire only the signal light in the deep-ultraviolet wavelength region. Subsequently, it used the transceiver system it had developed to make direct measurements of the eye pattern during the day, outdoors and in a non-line-of-sight experimental configuration with office build-

ings, etc., blocking the light between the transmitter and receiver. The results confirmed long-distance transmission up to a maximum of 80 m and a clear eye pattern at a communication speed of 1 Mbps.

This means that the team became the first in the world to succeed at optical wireless communication transmission over 1 Mbps at a maximum distance of 80 m during the day and outdoors, when there is strong background noise caused by sunlight, and in a non-line-of-sight (NLOS) environment with obstacles such as office buildings, etc. The team showed the possibility that high-speed optical wireless communication could be realized using high-strength deep-ultraviolet LEDs even under conditions with no clear line of sight such as when the light is blocked by buildings such as office buildings and trees, etc. This new technology is expected to dramatically expand the possibilities for the application of LED optical wireless communication, which had been limited to use under conditions with

a clear line of sight until now.

In the future, this is expected to become an innovative technology which contributes to enhancing the safety and convenience of society through the creation of new usage situations for optical wireless communication, such as communication with drones and unmanned robots which cannot be seen due to obstacles such as office buildings, etc., vehicle-to-vehicle communication (V2V) and vehicle-to-infrastructure communication (V2I) at intersections, etc., with no clear line of sight, wireless communication in forests and mountainous regions which radio waves cannot reach easily, etc.

Reference

Hiroyuki Kurosawa, Sachiko Tsuzuki, Manabu Taniguchi, and Shin-ichiro Inoue, "Solar-Blind Optical Wireless Communications over 80 Meters Using a 265-nm High-Power Single-Chip DUV-LED over 500 mW in Sunlight," IEEE Photonics Journal, vol.15, Issue 3
 DOI: 10.1109/JPHOT.2023.3276176
 URL: <https://doi.org/10.1109/JPHOT.2023.3276176>

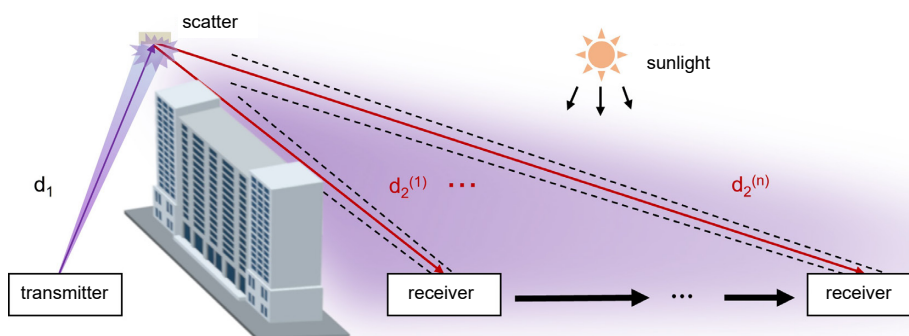
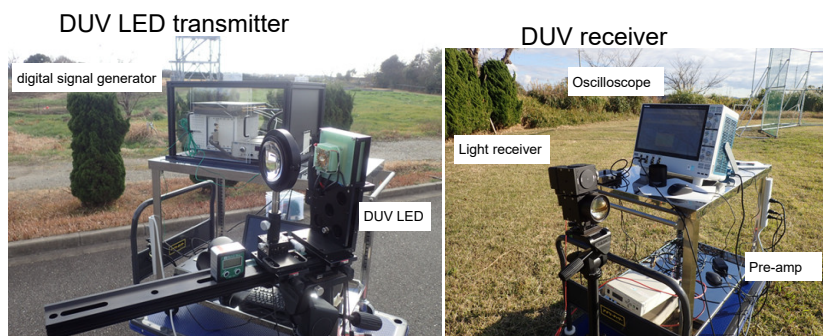

Fig.1 : Developed DUV transmission-reception system at the experiment

Cybersecurity Area

Development of a cross-organizational analysis function of the integrated cyber attack analysis platform “NIRVANA Kai”

Toward the establishment of Nexus-Style security measures from stand-alone security measures

NICT, Cybersecurity Laboratory has developed, as a new function of the Integrated Cyber Attack Analysis Platform “NIRVANA Kai,” a cross-organizational analysis function that can gather attack information from multiple organizations and perform overview analyses straddling

organizations in accordance with the attack description framework of MITRE ATT&CK. It is expected that this will enhance the cyberattack response capability of Japan by shifting from the stand-alone security measures which were conventionally carried out independently by each organization to new

nexus-style security measures under which multiple organizations loosely collaborate centered on an organization which serves as the node.

We presented a dynamic exhibition of NIRVANA Kai’s cross-organizational analysis function at Interop Tokyo 2023, which was held in Makuhari Messe

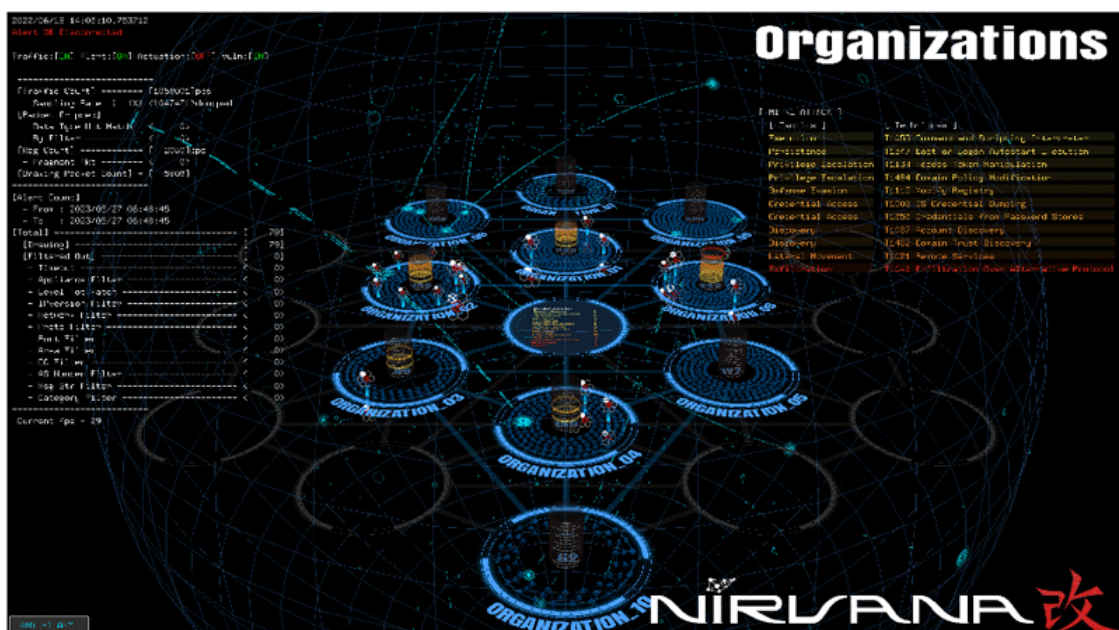

Fig.1 : Cross-organizational Analysis function of NIRVANA KAI

from June 14 (Wednesday) to June 16 (Friday), 2023.

“Stand-alone” security measures, which independently introduce and operate security products and services for each organization, have become mainstream for responding to the cyberattacks which occur daily. However, we are approaching a situation in which it is difficult technically and in terms of cost for an organization to respond ap-

propriately and quickly to increasingly sophisticated and diverse cyberattacks on its own. To date, NICT has advanced R&D into the Integrated Cyber Attack Analysis Platform “NIRVANA Kai” that can prioritize alerts within an organization and block abnormal communication. NIRVANA Kai was a stand-alone security measure operated independently by each organization, but this time, we have developed a new func-

tion which is a cross-organizational analysis function that enables NICT to gather attack information from multiple organizations and perform overview analyses straddling organizations (Fig. 1).

Reference

<https://www.nict.go.jp/press/2023/06/13-1.html>
(in Japanese)

Universal Communication Area

Building prototype Japanese language specific Large Language Models (LLM, Generative AI)

The development of generative large language models using Japanese language web data

The Data-driven Intelligent System Research Center (DIRECT) at the NICT Universal Communication Research Institute used 350 GB of learning data derived from refining independently collected Japanese language web texts to develop a Japanese language-specific, generative large language model with 40 billion parameters and announced it to the media in July 2023. Subsequently, by December 2023, we have gathered insights from this model to develop even more powerful models, and the learning data was used to develop generative

large language models of 13 billion parameters, 179 billion parameters, which is the same scale as OpenAI’s GPT3, and a significantly larger model of 311 billion parameters. In addition, we are working on increasing the scale of the texts used for the learning, and a model of 13 billion parameters built using 888 GB of learning data is already in operation. Currently, we are comparing these models to consider configurations and other crucial elements necessary to establish the future models. To date, we have confirmed that the accuracy of the answers to the questions improves with

a greater number of parameters (although the 311 billion parameter model has not been evaluated yet.), and we have discovered that if we can automatically choose the optimal answers from the answers of multiple models, then we can generate appropriate answers with an accuracy above 90 %. (Although the accuracy was assessed without thoroughly fact-checking the answers.)

To date, NICT has gathered a large volume of web pages and implemented R&D to effectively utilize the knowledge available on the Internet. After BERT, an identification-type language model, was

announced in 2018, we used independently gathered web texts to build a Japanese language specific version of BERT in 2020, and achieved the world's highest performance figures with open Japanese language benchmark data (JGLUE). In addition, we added further unique improvements and utilized BERT in the deep learning version of WISDOM X, a large-scale web information analysis system, which we commenced the trial release in 2021, and in the MICSUS dialog system for supporting care of the elderly and other various systems. We have confirmed its high performance in many large-scale demonstration experiments in fields such as elderly care.

Meanwhile, regarding generative language models, a variety of models have been developed, including GPT, announced in 2018, but the risks of false information, bias and various kinds of abuse were indicated. Therefore it was anticipated that the social implementation of these models requires considerable progress to be made. This led us to the decision not to implement large-scale R&D into generative language models. However, since the appearance of ChatGPT in 2022, generative language models have gained a huge amount of attention and strengthening Japan's R&D

capabilities has become an urgent issue. As a result, NICT commenced full-scale development of generative language models from March 2023.

The series of generative large language models we have developed during this period are not at a level comparable to ChatGPT or other prominent models in terms of performance, but even though we have only implemented prior learning, as shown in the figure, they can generate a diverse range of Japanese language text in response to the input. It is able to answer questions, has creative writing capabilities, can summarize and translate sentences, and even participate in a discussion with its users. In order for us to advance our research, firstly, we will use approximately 45 billion pages of web data independently gathered to date, to facilitate a further increase in the scale of the Japanese language text for learning. Furthermore, regarding the information in text generated by large language models, we plan to work on technologies which effectively reduce the generation of false information by using WISDOM X to carry out fact-checking using text written by real people, and continue to work on the upgrading of MICSUS and other tools using large language models. In addition, NICT has conduct-

ed research into technologies which generate "edgy" or "unexpected" future scenarios and hypotheses which no one has thought about and are not found on the web or other forms of media. We will continue to utilize such technologies in brainstorming and other applications that use dialog systems. The large language models and other technologies we have developed so far will be widely utilized in these research projects as well. Moreover, we plan to expand our joint research with private companies, universities, national research institutes and other organizations to provide large volumes of high-quality data for learning, and engage in industry-academia-government collaboration to work on R&D and beyond, but also enabling large language models to be utilized in a safe and trustworthy manner.

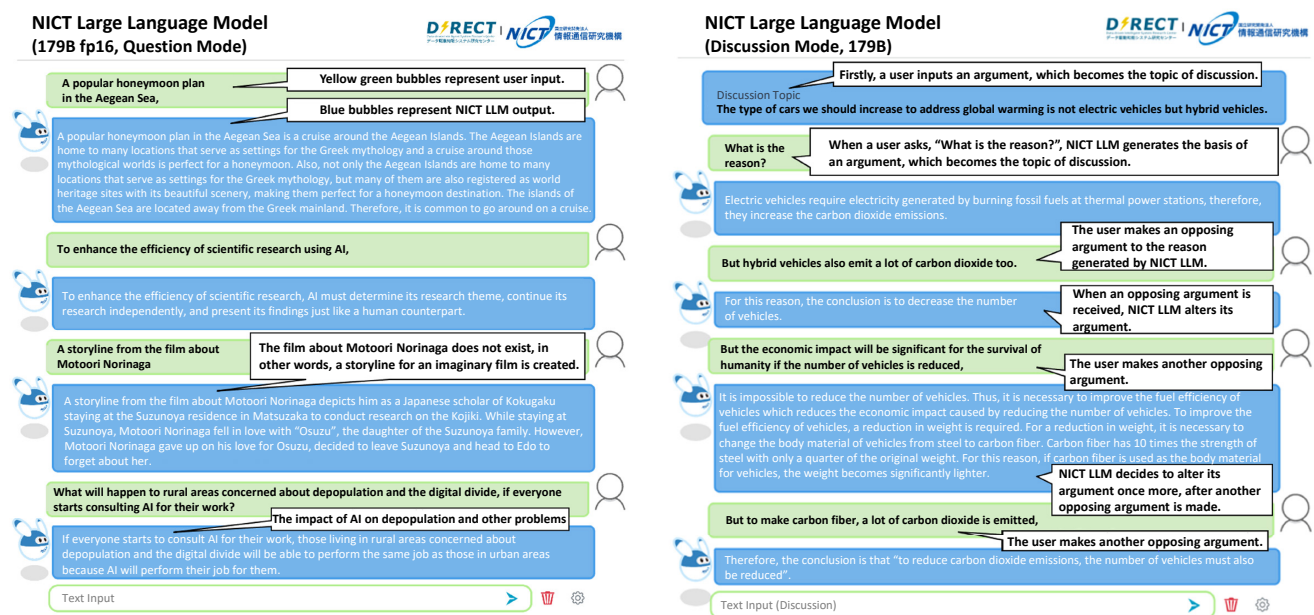

Fig.1 : Demonstration of NICT Generative Language Model (Examples above were originally written/generated) in Japanese)

B5G Field

Establishment of accurate permittivity measurement technology using the Millimeter wave/Terahertz band

Contribution to the development of receivers for radio telescopes and the development of materials for use in Beyond 5G/6G

A research team comprised of researchers from NICT and the National Astronomical Observatory of Japan (NAOJ) has invented an analytical method which can measure the electrical properties of insulators 100 times more accurately than before. This technology is expected to contribute to the development of receivers for radio telescopes as well as to the development of devices for the next generation communication networks, Beyond 5G/6G.

NAOJ and NICT have jointly been conducting R&D for high-precision material property measurement systems in

the millimeter wave/terahertz band. The subject of the research by the research team on this occasion was the "permittivity" value that indicates how electrons inside an insulator react when a electric field is applied to the insulator, which blocks electricity. Permittivity is an important parameter for understanding the behavior of radio waves as they travel through insulators. In radio telescopes, radio waves coming from outer space sometimes pass through the lens as they are guided from the antenna to the receiver. In order to develop radio telescopes with the performance that astronomers require, it is necessary to

accurately measure the permittivity of the lens. Furthermore, in the field of communications, accurate measurements of the permittivity of the materials in the circuit boards and antennas used in communications devices and the permittivity of the construction materials used in the buildings through which radio waves pass are required.

Conventionally, there are several methods used for measuring permittivity. With the "resonance method," the material to be measured must be placed in a device called a resonator to be measured, which requires precision processing of the material to a size which fits into the resonator (sometimes less than several hundred micrometers thick). Another drawback is that the permittivity can only be measured at several specific frequencies. On the other hand, with the "free-space method," an approximation has been used to analyze the measurement results, and the error caused by this makes accurate measurement difficult.

By devising a measurement method for electromagnetic wave propagation, the research team developed an analytical algorithm that derives the permittivity rigorously rather than by approximation while still using the "free-space method." When the team conducted a

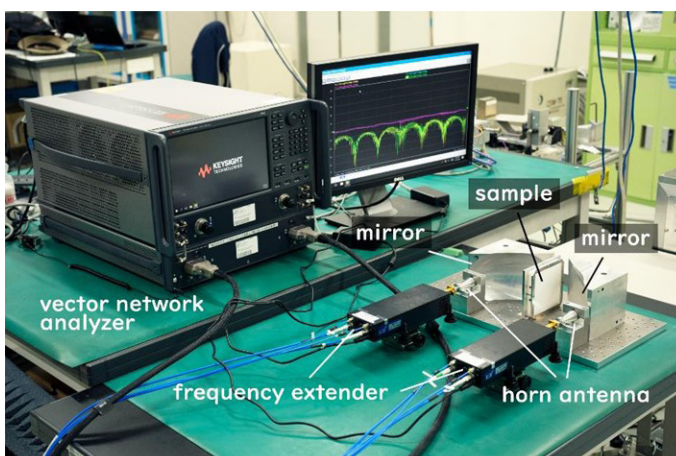

Fig.1 : Photo of the permittivity measurement system

verification of the validity of this analytical technique, they were able to demonstrate that it is possible to reduce the error due to approximation by a factor of 100 compared to conventional analytical methods; therefore, measuring the permittivity accurately. Furthermore, when they used the new technique to actually measure candidates for lens materials in the receivers being developed for the Atacama Large Millimeter/submillimeter Array (ALMA) telescope,

they confirmed that the results were consistent with other methods, demonstrating the effectiveness of the new technique in actual device development. This means that the team has been able to establish technology to accurately measure the permittivity of materials in the millimeter wave/terahertz band over a wide frequency range.

These research results were presented in the scientific journal *IEEE Transactions on Terahertz Science and*

Technology on July 3, 2023.

Reference

Ryo Sakai, Alvaro Gonzalez, Keiko Kaneko, Hiroaki Imada, Takafumi Kojima, Norihiko Sekine and Yoshinori Uzawa, "Accurate Free-Space Measurement of Complex Permittivity With the Angular Spectrum Method," *IEEE Transactions on Terahertz Science and Technology*, Vol. 13, Issue 4, July 2023
DOI: 10.1109/TTHZ.2023.3272041
URL: <https://doi.org/10.1109/TTHZ.2023.3272041>

Researchers

Person 1



Pham Tien Dat

Senior Researcher, Optical Access Technology Laboratory, Photonic ICT Research Center, Network Research Institute/ Senior Researcher, Terahertz Laboratory Terahertz Technology Research Center, Beyond 5G Research and Development Promotion Unit

After receiving a doctorate degree in science from Waseda University, he joined NICT in 2011. He has been involved in the research and development of millimeter-/terahertz photonics, optical wireless systems, and seamless access networks. Ph.D.(Science).

Photonics-enabled millimeter-/terahertz-wave signal processing for unprecedented communication features and applications

The popularization of smart devices and the increase in demand for broadband connectivity have led to the congestion of radio communications in the low-frequency bands. Shifting radio communications to higher frequency bands, such as the millimeter-wave and terahertz-wave band, is crucial for realizing high-speed and low-latency services. Nevertheless, radio communications in the high-frequency bands encounter significant challenges owing to their large free-space and penetration losses. Seamless access networks in which radio waveforms are transmitted over fiber links and radio-wave signals are generated using simple media converters at the antenna sites are considered cost-effective and flexible solutions. In these networks, photonic technology is primarily used to generate and transmit high-quality radio signals in addition to detecting, controlling, and processing the radio signals to overcome the bottlenecks in conventional networks.

Since joining NICT in 2011, I have been involved in the research and development of seamless access networks using photonic technology as the key driver. Among numerous achievements, we successfully demonstrated several novel systems using radio communications in the millimeter-/terahertz-wave band, such as a high-speed, uninterrupted communication system for rapidly moving users using radio-over-fiber and optical switching technology [1], direct reception and down-conversion of 100-GHz radio signal using an all-optical method [2], as well as transparent relay and switching of terahertz signals in the 285-GHz band based on photonic technology [3]. With the evolution of radio communications to the high-frequency bands, I believe that photonic technology and its interactions with radio counterparts will play a crucial role in facilitating the development of future communication networks.

hertz signals in the 285-GHz band based on photonic technology [3]. With the evolution of radio communications to the high-frequency bands, I believe that photonic technology and its interactions with radio counterparts will play a crucial role in facilitating the development of future communication networks.

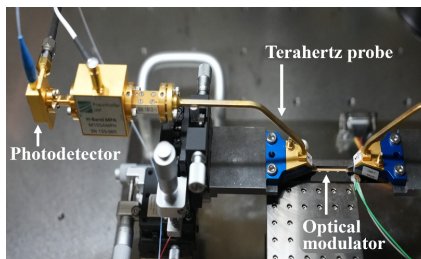

Fig.1 : Photo of direct optical-terahertz and terahertz-optical conversion

[1] NICT press release, May 8, 2018. <https://www.nict.go.jp/en/press/2018/05/08-1.html>
 P. T. Dat et al, "High-speed and handover-free communications for high-speed trains using switched WDM fiber-wireless system" Optical Fiber Communication Conference (OFC), paper Th4D.2, 2018.
 [2] NICT press release, August 6, 2021. <https://www.nict.go.jp/en/press/2021/08/06-1.html>
 P. T. Dat et al, "Transparent fiber-radio-fiber bridge at 101 GHz using optical modulator and direct photonic down-conversion" Optical Fiber Communication Conference (OFC), paper F3C.4, 2021.
 [3] NICT press release, June 6th, 2023. <https://www.nict.go.jp/en/press/2023/06/06-1.html>
 P. T. Dat et al, "Transparent Relay and Switching of THz-wave Signals in 285-GHz Band Using Photonic" Optical Fiber Communication Conference (OFC), paper Th4A. 6, 2023.

Q&A

What is the most interesting point in your research?

Photonics and radio networks have been treated as distinct fields. However, it is possible to develop unprecedented communication features and functions by considering networks in an integrated manner and utilizing the interactions between the two fields. It is interesting to explore new applications and use cases based on interdisciplinary technologies and approaches.

What has been your happiest moment with your current research theme?

Extensive efforts are required to successfully propose and demonstrate new system concepts, including brainstorming new ideas, preparing plans, and performing experiments in which the underlying physical phenomena should be thoroughly predicted, understood, and analyzed. It is immensely satisfying when plans work as expected and new results are obtained following intensive efforts.

What are the social meaning /importance and future prospects of your research?

Inherent limitations in the current millimeter-/terahertz-wave systems should be resolved to facilitate practical applications. My research aims to overcome the bottlenecks in the current systems and develop solutions for new applications using an interdisciplinary approach. Accordingly, high-speed and energy-efficient systems can be realized for sustainable development in the future.

Researchers

Person 2



JIN Hidekatsu

Senior Researcher,
Space Environment Laboratory,
Radio Propagation Research Center,
Radio Research Institute

Dr. JIN was born near Tokyo in the 1970s. After conducting doctoral research in a laboratory at JAXA/ISAS, he joined NICT in 2004. He has been involved in the research and development of space weather modeling and its applications.

Ph. D. (Science)

Challenge of atmospheric air drag prediction

In recent years, numerous satellites have been launched into low-earth orbits (LEO) for applications such as communications and remote sensing. Many of these satellites pass through a layer of the atmosphere called the thermosphere at altitudes less than 600 km, and are subject to air drag from the atmosphere. The air drag varies with the background atmospheric conditions on various time scales and amplitudes. Such variations can threaten satellite operation, including control of satellite orbits and management of collision risks with other satellites and space debris. The atmospheric event in February 2022, when a magnetic storm caused air drag to increase by 50% and 38 communication satellites to drop into the lower atmosphere, is emblematic of this.

Reducing the threat of such air drag requires atmospheric models that predict the distribution and temporal change of the thermosphere. A team of researchers from NICT, Kyushu University, and Seikei University has been developing a simulation model called

GAIA (Ground-to-topside model of Atmosphere and Ionosphere for Aeronomy) for the Earth's entire atmosphere, from the atmosphere near the surface to the thermosphere and ionosphere[1]. A real-time simulation system using GAIA has been operated since 2020, providing reference information for daily space weather forecasts[2].

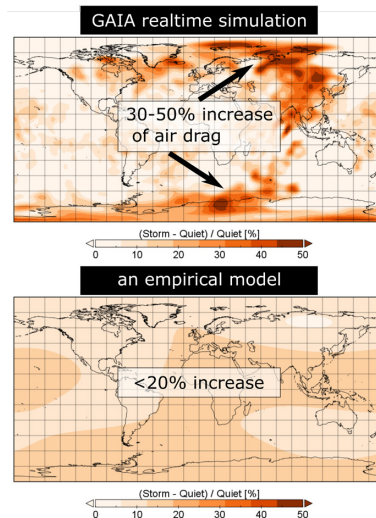

Fig.1 : Simulation using GAIA

The real-time simulation of the February 2022 magnetic storm shows a 30-50% increase in atmospheric mass density over a wide latitudinal range at an altitude of 200 km, consistent with observations of air drag, indicating that the use of a physics-based model like GAIA would be useful for future operation at these altitudes, where there have been few observations, which has made it difficult for observation-based empirical models to reproduce atmospheric changes[3].

[1] Jin, H., Y. Miyoshi, H. Fujiwara, H. Shinagawa, K. Terada, N. Terada, M. Ishii, Y. Otsuka, and A. Saito (2011), Vertical connection from the tropospheric activities to the ionospheric longitudinal structure simulated by a new Earth's whole atmosphere-ionosphere coupled model, *J. Geophys. Res.*, 116, A01316, doi:10.1029/2010JA015925.

[2] Tao, C., Jin, H., Miyoshi, Y. et al. Numerical forecast of the upper atmosphere and ionosphere using GAIA. *Earth Planets Space* 72, 178 (2020). <https://doi.org/10.1186/s40623-020-01307-x>

[3] NICT press release, "磁気嵐の発生メカニズムと大気シミュレーションから多数の低軌道衛星が喪失に至った原因を解明 | " Dec 27, 2022. (in Japanese)

<https://www.nict.go.jp/press/2022/12/27-1.html>

Q&A

What are the social meaning / importance and future prospects of your research?

Since the number of LEO satellites is rapidly increasing, it will become more important to manage the risk of collisions between satellites or between satellites and space debris. The development of atmospheric models that predict atmospheric air drag with high accuracy would contribute to stable operation of LEO satellites.

How is your research positioned in the relevant research area?

The lower thermosphere at 80 to 250 km altitude is a frontier of upper atmospheric research, where important physical mechanisms connect effects from the sun and magnetosphere and from the lower atmosphere. This region is a black box where there have been few observations. Thus, analysis of the atmospheric event in February 2022 using atmospheric models can contribute to understanding this region.

What are you aiming at as a researcher?

The goal of our project is to develop a simulation model that accurately predicts changes in the thermosphere and ionosphere, and to apply it in satellite operations, positioning, and communications. For this purpose, we are trying to integrate observed data obtained in the real world into GAIA, which operates in cyberspace.

Researchers

Person 3



IWAKI Mitsuhiro

Senior Researcher,
Bio-ICT Laboratory,
Kobe Frontier Research Center,
Advanced ICT Research Institute

Dr. IWAKI was born in Miyazaki City, in 1977.

After earning his doctorate, he was a deputy team leader at RIKEN, before joining NICT in 2022.

He has been involved in research of the information processing of biological systems.

Ph.D.(Biophysics)

Understanding mechanical information processing involving biological fluctuations and contributing to next-generation computer design

The energy that cells and brains use to process information is much smaller than the electrical energy used by computers, and the information-processing biomolecules function while fluctuating thermally. If we can understand the mechanism of probabilistic information processing under such fluctuations, we can potentially contribute to the design of next-generation, ultra-energy-saving computers. It is well known that living organisms exchange information with each other using chemical molecules, such as neurotransmitters, and electricity, but recently, we have learned that mechanical forces also serve as signals for exchanging information. Although mechanical information processing can be analyzed using

information physics, for which a theoretical framework has been constructed in recent years, there was a lack of tools to visualize the essential mechanical forces, so understanding of the mechanisms lagged behind. Therefore, we utilized a technology called DNA origami to develop a force sensor for visualizing the forces. It is possible to detect minute forces at the thermal noise level using the world's smallest coiled spring with a mo-

lecular size. We succeeded in detecting, with high sensitivity, the minute forces input into the cells by connecting the spring to the cells [1][2]. Going forward, we hope to be able to understand the energy-saving information-processing mechanisms of living organisms by visualizing the mechanical signals and also advancing observations of the behavior of the biomolecular systems that use the fluctuations to carry out information processing.

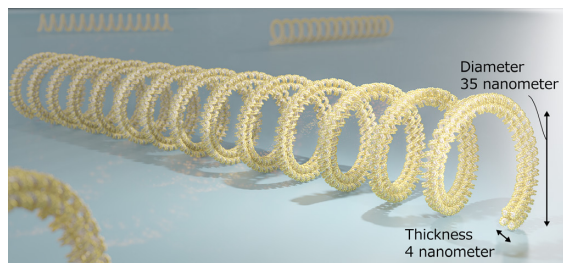

Fig.1 : The world's smallest coiled spring developed to visualize minute mechanical signals to cells

[1] H. Matsubara, H. Fukunaga, T. Saito, K. Ikezaki, and M. Iwaki, "A programmable DNA origami nano-spring that reports dynamics of single integrin motion, force magnitude and force orientation in living cells," ACS Nano 17, 14, pp. 13185–13194, 2023.

[2] NICT press release, July 3, 2023. <https://www.nict.go.jp/press/2023/07/03-1.html> (in Japanese)

Q&A

What is the most interesting point in your research?

Through research combining fields such as biology, physics, and engineering, I am attempting to understand the extraordinary abilities of living organisms and use that understanding for engineering applications and social implementation.

What are the social meaning/importance and future prospects of your research theme?

Due to the growing volumes of information processing in modern society, the amount of electricity needed by society is expected to increase substantially. I hope to study the mechanisms of living organisms, which carry out complex information processing highly efficiently, and develop new concepts that can contribute to the development of power-efficient next-generation computers.

What are you aiming at as a researcher?

We cannot make new discoveries or innovative developments simply by following trends. My aim is to conduct research that will remain relevant 100 years from now, using unique techniques and perspectives.

NICT Overseas Centers

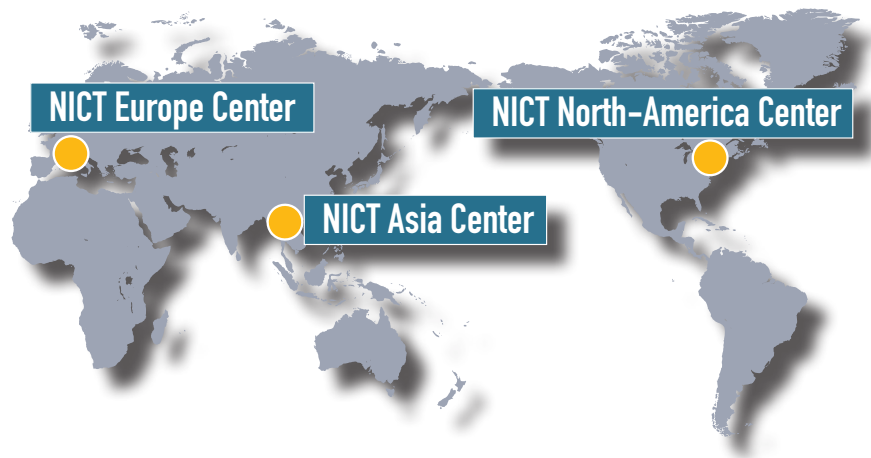

Disseminating NICT's Accomplishments Globally

As hubs to support NICT's international expansion, NICT has established the North American Center in Washington, D.C., the USA, the Europe Center in Paris, France, and the Asia Center in Bangkok, Thailand. At each of these overseas centers, along with spreading information and publicizing NICT's research and development accomplishments, we gather the latest information on ICT policy and research and development trends in each region that can only be obtained on the ground by networking with experts and specialists. In addition, we find cooperative research partners and develop relationships with them, provide planning and assistance to enable cooperative research to progress smoothly, and manage communications with said partners.

Specifically, the North-America and Europe Centers gather and analyze the latest information on policies and technological

trends related to cutting-edge ICT such as wireless systems and cyber security, quantum communication, and AI in order to effectively and efficiently advance international research cooperation and international standardization activities at NICT. We provide this information and analysis to the relevant departments within NICT such that it may be used effectively in NICT's research activities. We also explain NICT's research and development initiatives to each region's government agencies, research facilities, universities, organizations, and other stakeholders, striving to network with them. As part of the international expansion of NICT's research and development accomplishments, along with hosting NICT's own international seminars, we also proactively participate in events such as international exhibitions.

In addition, at the Asia Center, along with

gathering regional information in Southeast Asia and developing networks with relevant agencies, we promote and support collaborative research projects through the activities of ASEAN IVO (ICT Virtual Organization of ASEAN Institutes and NICT), a virtual research-cooperation organization with research facilities and universities within the ASEAN area. We also strive to improve NICT's presence in the region by participating in exhibits and assisting with workshops through the coordination and cooperation of the relevant departments within NICT. Furthermore, we act as an intermediary for the utilization of NICT's research and development accomplishments on the basis of the research needs of the ICT field in the region.

Here, the general directors of each overseas center introduce their centers' recent Activities.



The NICT Asia Center strives to strengthen relationships with research institutes, universities, and others, to support the R&D activities of NICT, and to disseminate information on NICT activities, primarily in Southeast Asia. Over more than 20 years, including those of the former CRL Asia Research Center, which was established in Bangkok in 2002, the NICT Asia Center has advanced various initiatives while adapting to changes in the region's information and communications R&D environment.

In 2015, the center was relocated inside Chulalongkorn University, and we are advancing research collaboration with the university primarily in the photonic networks field. We held the CU-NICT Workshop on Photonic Network Research 2023 jointly with the university in November 2023. After opening addresses by Dr. Supot Teachavorasinskun, Dean of the Faculty of Engineering, Dr. Naebboon Hoonchareon, Head of the Electrical Engineering Department, Dr. YASUI Motoaki, Vice President of NICT and Mr. NISHINO Hisanori, Director of Asia Center, NICT, research presentations were given about technologies related to photonic networks as well as a wide range of technologies with the aim of expanding collaboration, including optical wireless communication, and optical fiber sensors for biomarker detection.



Group photograph at the CU-NICT Workshop on Photonic Network Research 2023 (Dr. Supot Teachavorasinskun, Chulalongkorn University's Dean of the Faculty of Engineering (center right), Dr. YASUI Motoaki, NICT Vice President (center left))

For the dissemination of information, we are also actively participating in exhibitions and related events. At the National Science and Technology Fair hosted by the Government of Thailand in August every year, we hold exhibits where we present an overview of NICT activities and our research collaboration with the universities and public research institutes of Thailand. Thai dignitaries also tour the venue and during the tour by (then) Deputy Prime Minister and Minister of Foreign Affairs Don Pramudwinai in August 2023, NICT Vice President YANO Hiroyuki gave him an explanation about our research collaboration activities in Thailand. We also gave explanations in the Thai language to a wide range of visitors to the fair in cooperation with the professors and students of Chulalongkorn University and King Mongkut's Institute of Technology Ladkrabang (KMITL), our research collaboration partners.

Together with KMITL, we held an exhibit at the KMITL Innovation Expo (April 2023) concerning our research collabora-

tion in the space weather forecasting field (observations and forecasting concerning solar flares and ionospheric variations, etc.) and had an opportunity to explain the exhibit to Privy Council President Surayud Chulanont. We are advancing various other collaborative activities with KMITL as well, including the KMITL Space Hub Thailand (September 2023), where NICT Space Environment Laboratory Director TSUGAWA Takuya participated as a panelist.

Moreover, we have actively engaged in various events toward research collaboration, such as reporting our activities at the APT Telecommunication/ICT Development Forum (October 2023) and the IEEE Thailand Section Annual General Meeting (November 2023).

Our center will continue to strive to support research collaboration in the post-COVID-19 era, primarily in Southeast Asia, not only through online meetings but also by providing onsite research support and holding in-person workshops, among other efforts.



National Science and Technology Fair (Dr. YANO Hiroyuki, NICT Vice President (left), explained the content of the NICT exhibit to Mr. Don Pramudwinai, Deputy Prime Minister and Minister of Foreign Affairs (middle))

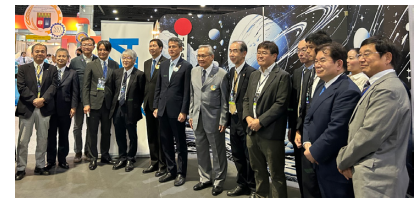

National Science and Technology Fair (Group photograph of Mr. Don Pramudwinai, Deputy Prime Minister and Minister of Foreign Affairs (middle), and members of the Japanese booth)



NICT Asia Center

100th Year Engineering Building, Room 703.
Floor 7th, Chulalongkorn University
254 Phayathai Road, Wang Mai, Pathumwan,
Bangkok 10330, Thailand
Tel & Fax: +66-2-252-1512
E-mail: int_asia@ml.nict.go.jp

A New Oasis in Bangkok

Benchakitti Forest Park is a newly opened park in central Bangkok, an area with rows of high-rise office buildings. A long skywalk stretches throughout the park, which forms an integrated landscape with the high-rise buildings in the background, and it provides a place of rest and relaxation for the local community.



Benchakitti Forest Park in central Bangkok

The North-America Center was established in October 2000. Its office is located near the center of Washington, D.C., within walking distance of the White House and federal government agencies. It is also quite close to the offices of other National Research and Development Agencies of Japan. For example, it is only a few minutes away on foot from the Washington, D.C. offices of the Japan Science and Technology Agency (JST) and Japan Agency for Medical Research and Development (AMED).

The work of the North-America Center is centered on the following three activities:

- (1) Promotion of joint research with U.S. research institutes
- (2) Information collection, analysis, and reporting of various U.S. government policies including budgets and regulations related to R&D in the field of telecommunications and of R&D trends at research institutes, universities, and private companies
- (3) Publicizing and promoting NICT R&D results by participating in exhibitions and meetings

In particular, we have been putting much effort into Beyond 5G/6G and quantum science and technology. The outcome document of the Japan-U.S. Summit Meeting held on April 16, 2021 made specific

mention of these fields and a Japan-U.S. Joint Leaders' Statement issued on May 23, 2022 announced the acceleration of their R&D. To strengthen Japan-U.S. cooperation in research, we have been making progress in exchanging opinions with agencies and organizations associated with the U.S. government and in participating in related meetings in the United States.

Startup companies are players having a significant impact not only in the field of information and communications technology but also on society and the economy overall in the United States. We have, therefore, been conducting surveys on venture capital and startup companies on an ongoing basis and have been collecting and analyzing trends in startups that use diverse advanced technologies including Beyond 5G/6G and quantum science and technology.

The rapid development of generative AI and its spread throughout society are bringing about significant transformations not only in information and communications technology and related industries but also in all economic activities and people's lives worldwide. Furthermore, the increasingly complex international environment significantly impacts a range of govern-

ment policies and R&D policy in the United States. In addition, the United States will have a presidential election in 2024. Even under such circumstances, the North-America Center will strive to accurately understand the situation in the United States, as well as contribute to advancing R&D in information and communications technology in Japan and the United States by sharing the situation in Japan in an easy to understand manner and serving as a bridge between the research communities in Japan and the United States.



NICT North-America Center

Office: 1020 19th Street NW
 Suite 880,
 Washington DC 20036
 Tel.: 202-857-0070
 Email: nac@ml.nict.go.jp

At the Center of World Economy

Many international exhibitions and conferences in the field of information-communications are held in the United States, since it is the center of the global economy. The North-America Center also attends and makes presentations at these meetings as part of its activities. For example, at CES (whose official name was changed from "Consumer Electronics Show" previously to "CES" now), which is held at the beginning of every year, representatives from digital device and service businesses, as well as related industries, get together from around the world, seeking the latest movements and trying to generate such movements themselves. Meanwhile, at the NAB Show, which is held in April every year with the National Association of Broadcasters (NAB) playing a central role, participants exhibit the latest broadcasting-related devices and services and have extensive discussions with the aim of overcoming a wide range of broadcasting issues and further developing this industry. Participating in these events is highly effective for both gathering and disseminating information. In addition, we believe these events are also valuable opportunities for experiencing the tremendous enthusiasm that organizers and participants have and to remind ourselves that this enthusiasm is likely the source of the US economy's great strength.



Fig. 1: Japan's startup booth at CES 2023



Fig. 2: NAB Show 2023, the centennial meeting

The NICT Europe Center is located in the business district near the Champs-Élysées, a street that is constantly crowded with tourists all year round. It is conveniently located close to the airport and major train stations in Paris, making it easy to travel within France and the European region from here.

The mission of the NICT Europe Center is to (1) promote and support international joint research through participation in international conferences and other events and deepen networks with European research institutes, government agencies, and industry organizations to promote collaboration, (2) support the international deployment of NICT R&D achievements in the European region through information dissemination and public relations, and (3) collect, analyze, and report information on R&D trends and policies in the ICT field at research institutes, government agencies, universities, and companies in the European region.

In Europe, green and digital transitions

are positioned as top priority policies, and large-scale programs are going forward to support their policies. These include Horizon Europe as a research innovation framework program, the Digital Europe Programme to promote implementation and expansion of digital technologies, and the Connecting Europe Facility to promote investment in network infrastructures across Europe. These programs include NICT's four strategic research fields of Beyond 5G/6G, quantum ICT, cybersecurity, and AI as priority fields, so it is an important mission of the NICT Europe Center to collect and analyze information on these European R&D trends and policies.

Furthermore, given a changing geopolitical situation and increasingly complex world affairs, there are many institutions in Europe that consider Japan to be an excellent partner that they can trust. Based on the above European trends, the NICT Europe Center acts as the main bridge between NICT headquarters and overseas institutions. With the aim of internationally

expanding R&D such as Beyond 5G and quantum ICT, we are making an effort to discuss and exchange views with European research institutes, government agencies, and related parties, actively participate in related events, and network with concerned individuals.

The NICT Europe Center will continue to proactively build mutually beneficial relationships between NICT and European research institutes and related organizations by using the knowledge and networks that we have built up here in Europe.



Fig.2 : Mobile World Congress 2023 held in Spain



Fig.1 : Lecture by NICT President TOKUDA Hideyuki at 6GEM in Germany

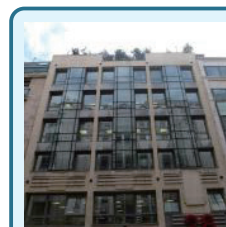

NICT Europe Center

28 rue de Berri 75008

Paris FRANCE

tel: +33 1 40 76 08 97

E-mail: europecenter@ml.nict.go.jp

Inside and Outside Paris

With fewer restrictions on COVID-19, everyday life has returned to France. Tourists are returning to Paris, and hotel prices are soaring across the board. Since my assignment to Paris this summer, the city has hosted a variety of events every week, including Paris Fashion Week, Paris Art Week, the European Heritage Days, and the Grape Harvest Festival in Montmartre. Paris never stops.

On a day off, I travelled around the Normandy region, including Mont-Saint-Michel. If you drive out of Paris, views of the peaceful countryside stretch on and on. I realized that France is not all urban. Then I encountered sheep relaxing at the foot of Mont-Saint-Michel at sunset, but shortly afterwards, I watched them all return to their house as they were chased by dogs along the road and recalled the mutton and lamb dishes at the local restaurants and thought to myself that the life of sheep is not that easy either.



Budget

The original budget for FY2023

Income from funded research or others during the fiscal year is not included.

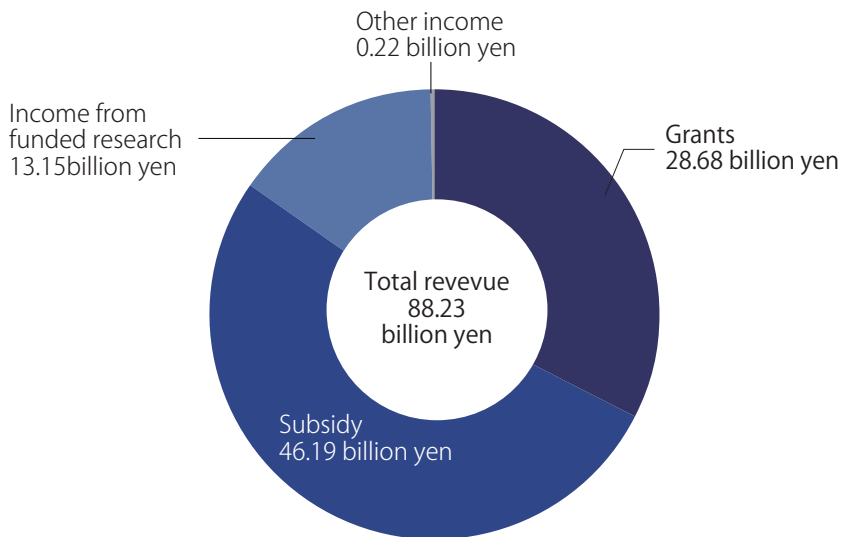

Total expenditure for FY2022 was billion yen in a reported basis.

Yen-dollar conversion ratio: 133.41yen/dollar (April 2023)

Work Force

1,337 (as of April 1, 2023)
(Including fixed term employees)



History

● Communications Research Laboratory (CRL) ● Telecommunications Advancement Organization (TAO)

- Oct. 1896 ● Radio Telegraph Research Division is established as a part of the Electrotechnical Laboratory, Ministry of Communications
- Jan. 1915 ● Hiraiso Branch opens
- May 1935 ● Testing and Examination for Radio Equipment Type Approval starts
- Jan. 1940 ● Frequency Standard Radio Service (JJY) starts (Kemigawa)
- June 1948 ● Radio Physics Laboratory is integrated
- Aug. 1952 ● Radio Research Laboratory is established
- May 1964 ● Kashima Branch opens (30-m diameter Parabola Antenna Facility completed)
- Aug. 1979 ● Communications and Broadcast Satellite Organization (CBSO) is established
- Aug. 1982 ● Kimitsu Satellite Control Center opens
- April 1988 ● Reorganized from Radio Research Laboratory to Communications Research Laboratory(CRL)
- May 1989 ● Kansai Branch opens (Kobe)
- Oct. 1992 ● Renamed as the Telecommunications Advancement Organization (TAO) Commencement of advanced communication and broadcasting research and development
- July 1997 ● Yokosuka Radio Communications Research Center is established
- July 2000 ● Keihanna Info-Communication Research Center is established
- Jan. 2001 ● Ministry of Posts and Telecommunications becomes Ministry of Public Management, Home Affairs, Posts and Telecommunications
- April 2001 ● Communications Research Laboratory, Incorporated Administrative Agency is established
- July 2001 ● Promotion system on facilitating research and development in private basic technology commences
- March 2002 ● Satellite control operations are terminated
- April 2003 ● Partial takeover of operations of Promotion Center for Facilitating Research and Development in Private Basic Technology
- April 2004 National Institute of Information and Communications Technology, an incorporated administrative agency (NICT) is established by merging CRL and TAO
- April 2012 Resilient ICT Research Center is established
- April 2013 Center for Information and Neural Networks(CiNet) is established
- April 2015 Renamed as National Institute of Information and Communications Technology, National Research and Development Agency
- April 2016 Cybersecurity Human Resource Development Research Center (Currently, National Cyber Training Center) is established
- March 2021 Beyond 5G R&D Promotion Project starts
- April 2021 Quantum ICT Collaboration Center is established

NICT Primary Facilities

Headquarters

- Koganei-shi and Kodaira-shi, Tokyo
- Radio Research Institute
- Network Research Institute
- Cybersecurity Research Institute
- Big Data Integration Research Center
- Koganei Frontier Research Center
- Beyond 5G Research and Development Promotion Unit
- Quantum ICT Collaboration Center
- Open Innovation Promotion Headquarters

- Resilient ICT Research Center
- Sendai-shi, Miyagi (Tohoku University Katahira Campus)

- Hokuriku StarBED Technology Center
- Nomi-shi, Ishikawa (Ishikawa Science Park)

- Universal Communication Research Institute
- Seika-cho, Souraku-gun, Kyoto (Keihanna Science City)

- Center for Information and Neural Networks
- Suita-shi, Osaka (Osaka University Suita Campus)

- Advanced ICT Research Institute
- Kobe-shi and Akashi-shi, Hyogo

- Ohtakadoya-yama LF Standard Time and Frequency Transmission Station
- Tamura-shi and Kawauchi-mura Futaba-gun, Fukushima

- Kashima Space Technology Center
- Kashima-shi, Ibaraki

- Innovation Center
- Chuo-ku, Tokyo

- Wireless Networks Research Center
- Yokosuka-shi, Kanagawa (Yokosuka Research Park)

- Hagane-yama LF Standard Time and Frequency Transmission Station
- Saga-shi, Saga and Itoshima-shi, Fukuoka

- Okinawa Electromagnetic Technology Center
- Onna-son, Kunigami-gun, Okinawa

Overseas Centers

- Asia Center
- North-America Center
- Europe Center



NICT REPORT 2024

Published : Jan. 2024

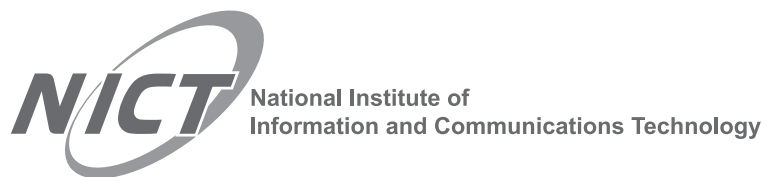

Public Relations Department
4-2-1, Nukui-Kitamachi, Koganei, Tokyo 184-8795, Japan
Tel : +81-42-327-5392
e-mail : publicity@nict.go.jp
URL : <https://www.nict.go.jp/en/>

Copyright © 2024 National Institute of Information and Communications Technology

